



CMC™

CATALOG 131



WELCOME TO CMC CATALOG 131

Welcome, and thank you for your interest in CMC. Catalog 131 reflects our unwavering commitment to improving customer outcomes, which began more than 45 years ago.

If you are already a CMC customer, we are honored and humbled to be trusted as your partner for life safety equipment and education. We hope you will find new products like the CAPTO™ and the SQUID™ to be problem-solvers that can make the work you do safer and more efficient.

If you are new to CMC, we invite you to explore our wide product range, knowing that these products have stood the test of time by life safety professionals the world over, and have become trusted tools of the trade along with the free and recently updated CMC App.

CMC is a 100% employee-owned business, and each of us accepts responsibility for living up to your highest expectations for the quality of our products, the levels of service we provide, our hands-on training, and the other educational resources we offer. Your voice is a critical part of helping us to improve everything we do so your feedback and questions are always welcome!

Best wishes on behalf of all CMC employee-owners,



Rich Phillips, CEO



cmcpro.com | info@cmcpro.com

US: 805-562-9120

GLOBAL: 800-235-5741

6740 Cortona Drive, Goleta, CA 93117 USA

CMC is an employee-owned company.

CONTENT



Education

Hands-on training, manuals and field guides, and digital resources for rope technicians interested in advanced techniques, best practices, and current industry standards.

Pages

1-9



Harnesses & Belts

Designed with input from our engineers, instructors, and most importantly, our customers, our harnesses deliver outstanding comfort and safety for technicians in a wide variety of industries.

Pages

10-27

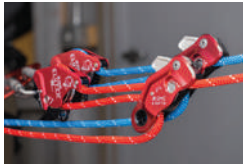

Hardware

New devices like the CAPTO™, SQUID™, and CMC CLUTCH™ by Harken™ are reshaping technical rope operations with their ease of use and ability to replace multiple pieces of equipment.

Pages

28-53

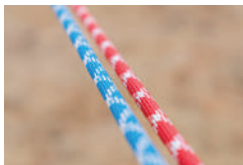

Rope & Web

Offering the latest materials and construction, our rope and web is crafted for high strength and durability, and built to perform without loss of integrity when exposed to the elements.

Pages

54-67



Anchors & Straps

CMC's innovative anchor devices, artificial high directionals, lanyards, and foot loops help technicians operate safe and efficient rope systems in virtually any environment.

Pages

68-85

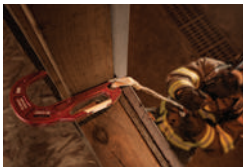

Fire Escape

Optimized for rapid and efficient egress, CMC's escape systems are compact, intuitive, and purpose-built for extremely volatile situations when personal escape and partner rescue are critical.

Pages

86-93



Bags & Packs

Built to maximize equipment organization, material durability, and carrying comfort, CMC's bags and packs work hard for rescuers and rope access technicians in tough environments.

Pages

94-107



Personal Gear

Essential for protection and performance on the job, CMC's personal gear provides the optimal balance of safety and comfort, durability and dexterity, and versatility and functionality.

Pages

108-119



Patient Care & Transport

Made for exceptional safety, rapid deployment, and comfortable transport, our equipment allows rescuers to move quickly while prioritizing the patient and maintaining a high standard of care.

Pages

120-133



Systems & Kits

Providing complete solutions for technical operations, CMC's kits contain the essential components for team-based rigging, as well as storage bags for easy organization and transport.

Pages

134-155





EDUCATION

LEARN BY DOING





CMC SCHOOL CLASSES

CMC offers open enrollment classes at various locations across the country. We provide training with practical application coursework in technical rope rescue, confined space rescue, trench rescue, wilderness rescue, and structural collapse shoring.



**CURRENT
CLASS
SCHEDULE**



Rope Rescue Technician I/II

This class covers NFPA 1006 Chapter 5 (Rope Rescue) Operations and Technician level skills. This intensive 40-hour, high-angle rescue class teaches skills required by fire departments, mountain rescue teams, and industrial rescue teams. Students will hone their fundamental skills and experience scenarios that reflect actual incidents.



Rope Rescue Technician III

This class is an advanced rope rescue training for professionals with previous training and experience. In this 40-hour class, students are challenged by scenarios that expand their rigging skills and problem-solving capabilities. With more than three decades of experience in teaching rope rescue, this curriculum was developed to dive deeper into more complex problems and rope rescue systems.



Confined Space Rescue Technician

This class addresses NFPA 1006 Chapter 7 (Confined Space Rescue) Operations and Technician Level Skills. This 40-hour Confined Space Entry and Rescue class provides hands on training and real-life scenarios allowing the student to gain confidence in this dangerous environment.



Trench Rescue Technician

This class covers NFPA 1006 Chapter 12 (Trench Rescue) Operations and Technician Level Skills for shoring and evacuation. This is a rigorous 24-hour class that provides hands-on training and real-life scenarios allowing the student to gain confidence in this dangerous environment. Students will leave understanding the risks, regulations, and tactics of this highly dynamic rescue discipline.



Structural Collapse Shoring

This 24-hour, hands-on class covers technician-level structural collapse and shoring. It meets FEMA Rescue Specialist requirements. Topics include Indications of collapse, formations of voids, building weight estimates, shoring principles and construction, stages of search and rescue, and victim recovery and extrication



REMS/Remote Rescue Workshop

This is an innovative 4-day training that goes beyond the traditional techniques taught in rope operations and technician course, introducing students to Rapid Extraction Module Support (REMS) concepts. Students learn to employ lightweight equipment not typically found in a standard rescue cache. This course is also designed to support the specific requirements and intent of FIRESCOPE ICS 223.



Arizona Vortex Workshop

This workshop is a 24-hour, hands-on workshop that progresses the student through the various configurations of the Arizona Vortex. The workshop covers basic set-ups, such as the easel "A" frame, to various bi-pod configurations and ultimately the monopod or "gin pole" set-ups. Students will leave with a clear understanding of the applied forces, modes of use, and vast utility of artificial high directionals.



Vertical Skills Class

This 3-Day, Vertical Skills Class will introduce a selection of Rope Access techniques specifically chosen to improve the rescuer's ability to move independently on rope. When the number of rescuers is limited, or the problem requires vertical movement, the ability to operate on a static line may offer the best solution for establishing quick patient contact.

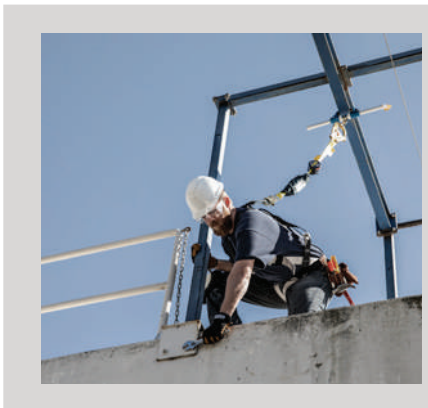

Don't see the class you want?

We will design one for you! In addition to the class offerings above, contract classes are available. Here are a few examples of what we can provide:

- Tower Rescue
- Rescue for Stage Riggers
- Rescue from Fall Protection
- Low Angle Rescue



**REQUEST
A QUOTE**

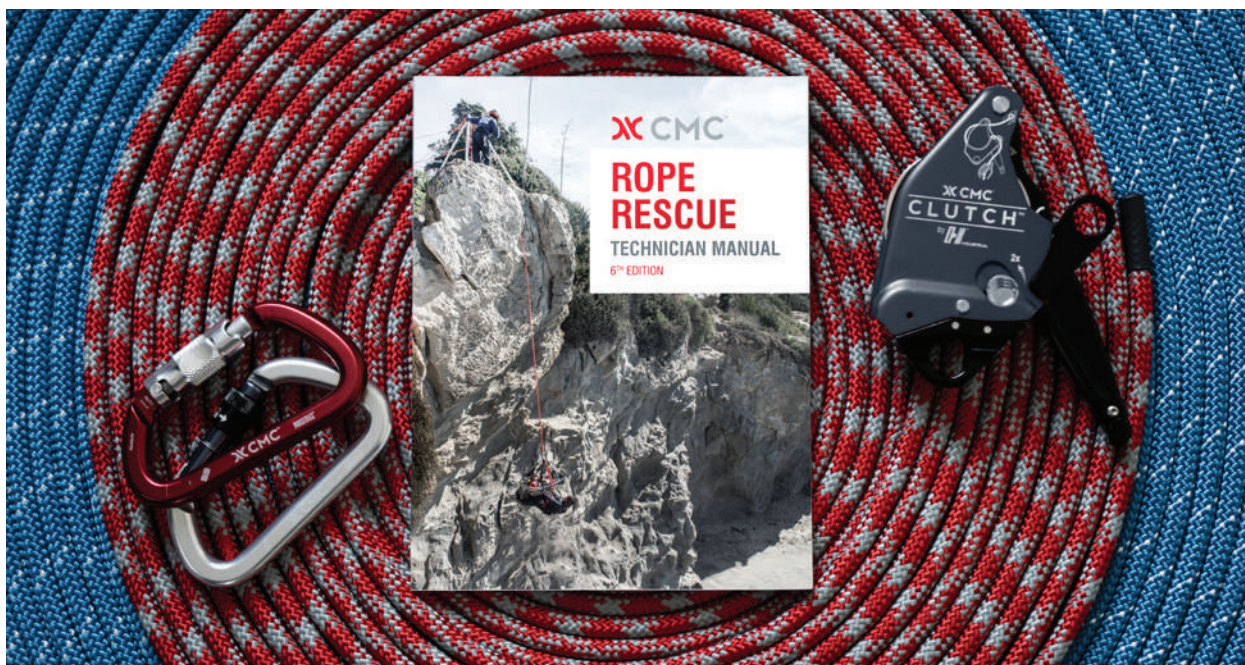

CMC MANUALS AND FIELD GUIDES

CMC manuals and field guides reflect the recommendations of leading authorities in rescue and rope access operations. While important knowledge can be gained by reading and studying books, there is no substitute for proper training and time spent in the field.

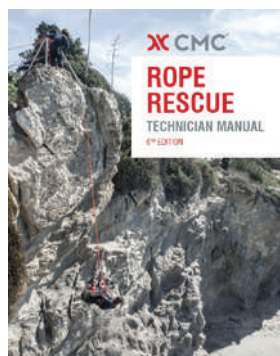

**eBOOK
AVAILABLE**

Rope Rescue Technician Manual

The CMC Rope Rescue Technician Manual has become the standard reference for many departments and rope rescue training programs. Edited by CMC founder Jim Frank, this manual cultivates over 40 years of responding to rescues and teaching thousands of students. The newest edition provides hundreds of photos and diagrams of lowering and raising systems, mechanical advantage, and rappel-based rescues.

Topics Covered Include

- Safety
- Testing
- Equipment
- Rappelling
- Pick-Offs
- Litter Evacuations
- Patient Packaging
- High Anchor Points
- Organizing the Response

Item #

993221



Rope Rescue Technician Field Guide

This pocket-sized companion to the *Rope Rescue Technician Manual* is printed on waterproof and tear-proof paper for durability in the field. Spiral-bound and measuring 10 x 15 cm (4 x 6 in), this guide fits into a radio harness or uniform pocket. 140+ pages. Also available for download in the free digital version using CMC's Field Guide App.

Item #

993232



Trench Rescue Technician Manual

Helping to prepare today's fire and rescue service to perform well organized and systematic trench and excavation rescues, the *Trench Rescue Technician Manual* was developed in collaboration with the California State Fire Marshal's Office. 235 pages.

Topics Covered Include

- OSHA Regulations
- Trench Hazards
- Victim Considerations
- Soil Basics
- On-scene Considerations
- Incident Termination
- Trench Configurations and Collapse Patterns
- Operational Safety
- Protective Systems

Item #

993202



Confined Space Rescue Technician Manual

The official textbook for the California State Fire Marshal's certified confined space courses, the *Confined Space Rescue Technician Manual* is also the manual of choice for fire departments and industrial rescue teams nationwide. The revised Second Edition has been updated and expanded. Color has been added to most of the more than 150 illustrations for improved clarity. 282 pages.

Topics Covered Include

- Communications
- Rescue Team Development
- Atmospheric Monitoring
- High Point Anchor Systems
- Assessment and Preparation for Entry
- Managing Hazards
- Laws, Regulations, and Permitting
- Organizing the Response
- Equipment
- Patient Transport

Item #

993214



Confined Space Rescue Technician Field Guide

This pocket-size book on waterproof and tear-proof paper contains a wealth of information from the *Confined Space Rescue Technician Manual*. Sections include classification and effects of hazards, ventilation charts, communications, rope work, and response management. The spiral-bound guide measures 10 x 15 cm (4 x 6 in). 88 pages.

Item #

993224

Gain free access to our field guides!

Through our CMC Field Guide App, gain access to CMC's Rope Rescue Technician and Confined Space Rescue Technician Field Guide, diagrams, reference charts, and videos.

Download free on iOS and Android



SCAN TO
DOWNLOAD!

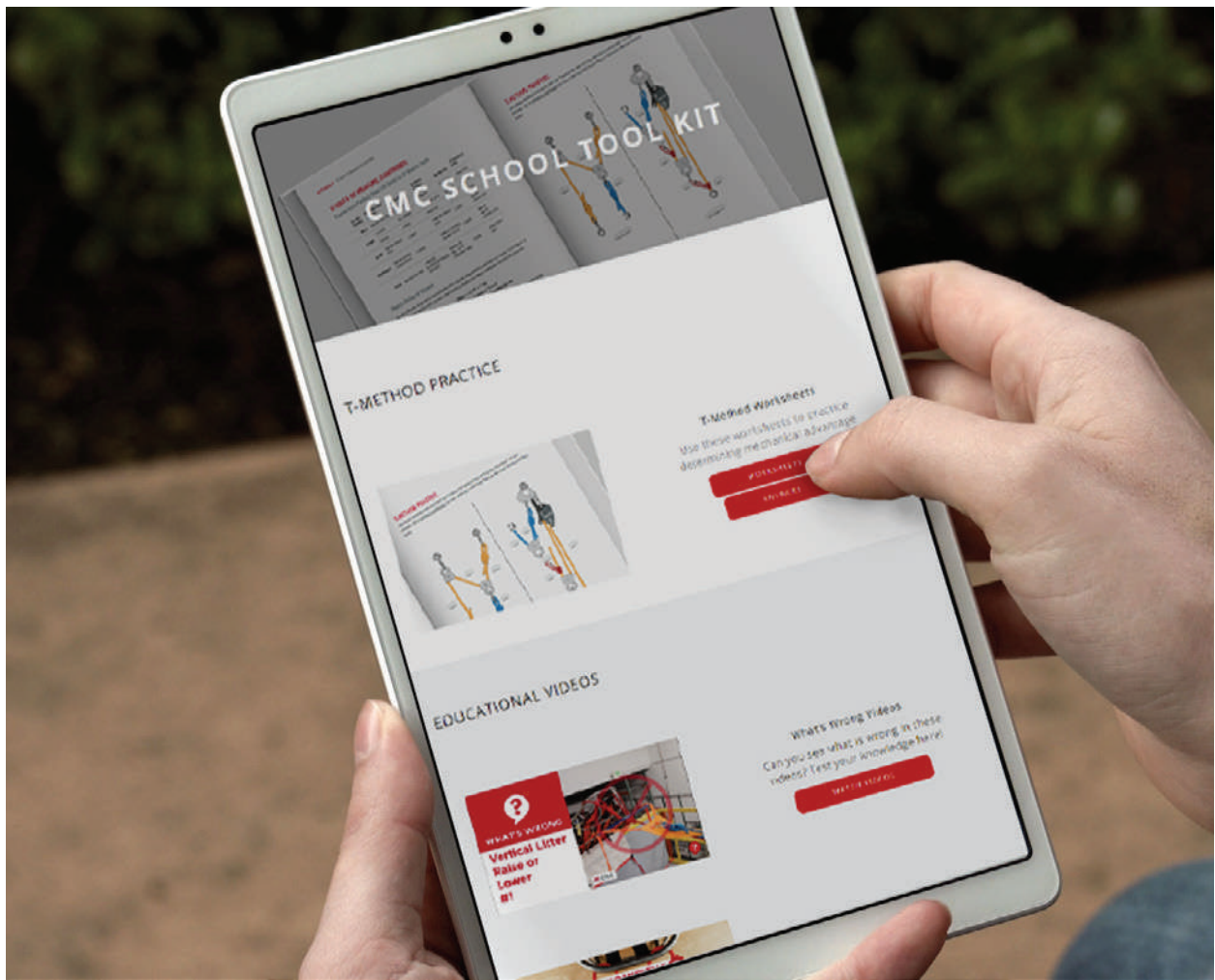

CMC TOOL KIT

Stay sharp with CMC's educational resources



SCAN TO
LEARN MORE!



CMC PODCAST

Hear round table discussions from CMC Instructors and other work-at-height and rope rescue professionals. Listen to some of our most popular episodes:

Myths in Rope Rescue: Rope rescue myths often start from a place of truth and evolve into misinformation over time. We cover a few of today's most pressing issues.

AZ Vortex Belay - High, Low, or Through an AZTEK?: This episode discusses what we do with our belay line when using an artificial high directional like the Vortex.

Find the CMC Podcast on your favorite podcast app.



EDUCATIONAL VIDEOS

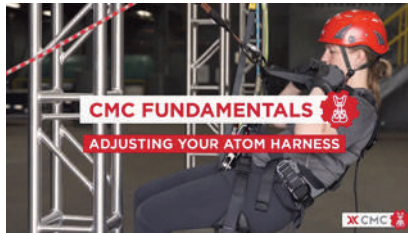

CMC Fundamentals

Watch our Fundamentals Videos to learn the basics or prepare for an upcoming CMC School Class! This series is designed to help you build your knowledge base. We cover knot tying, anchor building, M/A systems, applied forces, safety checks, proper harness adjustment, and more.



What's Wrong Series

Can you spot what's wrong? Watch our What's Wrong Series to test your technical skills and awareness in a variety of rigging scenarios. Challenge yourself to identify potential safety risks, and watch our explanation to see if you were right. Great for honing your safety checks and operating procedures.

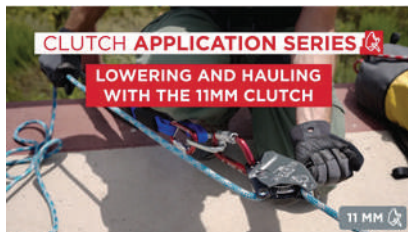

Application Series

In this in-depth video series, we provide detailed information on how to inspect, operate, and build systems using leading products like the CAPTO™ and CLUTCH™. Learn how to lower, haul, ascend, descend, and run twin tension rope systems in rescue and rope access environments.



CMC Pro Tips

Take the next step in your education by learning advanced techniques in our Pro Tips. These videos are intended to help you use CMC equipment more efficiently and provide guidance on preferred methods for critical operations. While Pro Tips are informative, they are not a replacement for proper training.

DIGITAL RESOURCES



eBook

CMC's Rope Rescue Technician Manual 6th Edition eBook features new chapters, diagrams, and techniques.

Now available for purchase on Google Play Books.

CMC Field Guide App

Free access to CMC's Rope Rescue Technician and Confined Space Rescue Technician Field Guide, diagrams, reference charts, and videos.

Download free on iOS and Android

XX CMC GRIMP

NORTH AMERICA
A GRIMPDAY^{EVENT}

GRIMP NA is an international rescue skills challenge hosted by CMC. The 2022 edition was held on the magnificent Battleship Iowa in Los Angeles, CA. We designed this event to provide an opportunity for education and spirited competition surrounded by peers. GRIMP NA brings the rescue community together to share ideas and techniques, with the ultimate goal of making rescues safer and more efficient. Under realistic conditions and time constraints, the 2022 teams pushed themselves to execute at the highest level in each of the challenging rescue scenarios. They accelerated their progression, and had a great time doing it! Thank you to the teams, sponsors, and evaluators who made GRIMP NA 2022 an unbelievable success. Visit our website to watch the highlight video and stay tuned for future events!









HARNESSES & BELTS





ATOM™ HARNESS SERIES

Our most comfortable and customizable harness, the ATOM is the culmination of re-imagining harness design from the most basic level to the most innovative features to create a performance-enhancing tool for rescue and rope access. The ATOM Harness incorporates years of detailed field evaluations and expert feedback from technicians who spend long hours in a harness. The end result is a true workhorse that redefines how a harness should feel and delivers the highest level of safety, comfort, and workflow efficiency.

Every detail in the ATOM Harness has been thoughtfully designed for the rope technician. The ATOM Harness enhances comfort with dual density foam padding and rolled edges that mold to the body and optimize load distribution. The low-profile fit and advanced architecture provide a high degree of mobility both on rope and on the ground. Available with customizable features, the ATOM Harness can be tailored to your personal preferences and job requirements. Choose your desired buckles, gear loops, attachment points, padding, web color, and accessories, or select from our extremely popular pre-configured options like the ATOM Rescue and ATOM Access.

Choose your preference

- Fully customized ATOM Harness. See page 13
- Pre-configured ATOM Harness. See pages 14-16

CUSTOMIZE YOUR ATOM™ HARNESS!



Shoulder picks:

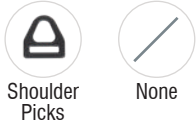

Shoulder pads:

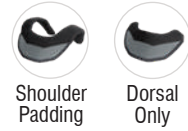

Accessories:

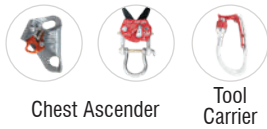

Web color:



Side attachments:



Attachment points:

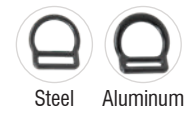

Gear loops:



Buckles:

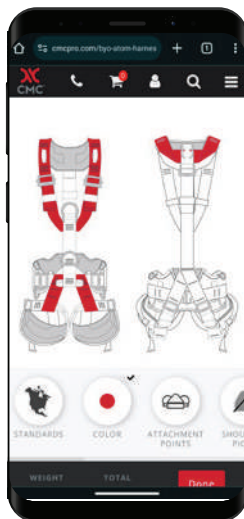

Build Your Own ATOM in Minutes!

Customizing your ATOM Harness is quick and easy using CMC's Build Your Own ATOM Tool. Visit our website to select your preferred features, see how it looks, confirm its certifications, get pricing, and place orders. Choose from a multitude of options to create your optimal ATOM.

There are over 10,000 possible combinations of the ATOM Harness, which will you choose?



BUILD YOUR OWN ATOM™

ATOM™ Rescue Harness

CONFIGURED FOR PROFESSIONAL RESCUE OPERATIONS



NFPA 2500 CLASS III
LIFE SAFETY HARNESS



ANSI Z359.11

CSA Z259.10

The ATOM Rescue Harness is configured with optimal features for professional rescue operations. Built with three quick-connect buckles for easy donning, steel attachment points for durability and strength, and contoured shoulder pads for all-day comfort. The ATOM Rescue Harness delivers on performance and safety while maximizing comfort.

Recommended for

Fire Rescue | Industrial Rescue | SAR

Features

- Red webbing at the shoulders and front leg drop for high visibility.
- Steel attachment points at the ventral, sternal, and dorsal locations are durable, low-profile, and high strength.
- Configured without side positioning points for reduced volume and snag potential, see custom options if side points are desired.
- Cobra quick-connect buckles at the legs and left shoulder make donning quick and efficient.
- One-piece shoulder pad reduces harness twisting to aid in donning.
- Bridged dorsal webbing provides improved comfort at the neck.
- Flexible gear loops offer low-profile gear stowage when working in tight or confined spaces.
- Workseat attachment points located at the waist are compatible with CMC SkySaddle™ (sold separately).
- A chest ascender (sold separately) can be added using CMC's ATOM Chest Ascender Kit or the ATOM MultiAscend Strap.

Color: Red/Black | Weight: 2.70 kg (5.95 lb)

Item #	Size	Waist	Leg Loop Circumference
202122	Small	66–81 cm (26–32 in)	51-91 cm (20-36 in)
202124	Medium	81–107 cm (32–42 in)	51-91 cm (20-36 in)
202125	Large	107–122 cm (42–48 in)	51-91 cm (20-36 in)



QUALITY CONSTRUCTION

CMC Harnesses feature corrosion resistant hardware, web keepers, and color contrast stitching to aid inspection.

ATOM™ Access Harness

DESIGNED WITH ESSENTIAL FEATURES FOR ROPE ACCESS



NFPA 2500 CLASS III
LIFE SAFETY HARNESS



EN 361; EN 358; EN 813



ANSI Z359.11

CSA Z259.10

The ATOM Access Harness is designed with features to meet the specific demands of rope access operations. Configured with an integrated chest ascender for mobility on rope, aluminum attachment points for lightweight strength, steel adjuster buckles for low-profile comfort, and tool loops for stowing equipment. The ATOM Access Harness is fully featured, low-profile, and every bit as durable as it is comfortable.

Recommended for

Rope Access | Industrial Rescue | Work Positioning
Law Enforcement | Military Operations

Features

- Large aluminum D-rings at the ventral, sternal, and dorsal attachment points keep the harness lightweight, and also fit multiple carabiners.
- Steel adjuster buckles are low profile and allow smooth adjustment.
- Aluminum side D-rings stow away until needed for work positioning.
- Unique integrated chest ascender design that centers the unit for efficient rope ascent, and enables replacement if necessary.
- Included Chest Ascender HC by Climbing Technology has a steel toothed cam and hard coat anodization that resists wear (**page 49**)
- Molded gear loops with high impact, cold resistant, polypropylene core provide easy gear stowage and retrieval.
- Four tool loops allow additional gear stowage (two at the rear waist and one at each leg pad).
- Workseat attachment points located at the waist are compatible with CMC SkySaddle™ (sold separately).

Color: Black | Weight: 2.71 kg (5.97 lb)

Item #	Size	Waist	Leg Loop Circumference
202222	Small	66–81 cm (26–32 in)	51-91 cm (20-36 in)
202224	Medium	81–107 cm (32–42 in)	51-91 cm (20-36 in)
202225	Large	107–122 cm (42–48 in)	51-91 cm (20-36 in)

LEARN MORE



Order your ATOM Harness with the **Harken Ninja™ MultiAscend** pre-installed through our Build Your Own ATOM tool on our website.



BUILD YOUR OWN ATOM™



HARNESSES & BELTS

ATOM™ Global Harness

COMFORTABLE AND EFFICIENT DAILY WORKHORSE



NFPA 2500 CLASS III
LIFE SAFETY HARNESS



EN 361; EN 358; EN 813



ANSI Z359.11

CSA Z259.10

The ATOM Global Harness is paired down to the essentials to create a harness that is lightweight, low-profile, and highly versatile for a wide range of work environments. Certified to European and North American standards, the ATOM Global Harness is configured with aluminum attachment points, soft web side attachments, steel adjuster buckles, molded gear loops, and four tool loops. Built for efficient daily operations.

Features

- Steel adjuster buckles are low profile and allow smooth adjustment.
- Soft web loop side attachment points are lightweight and accessible for positioning.
- Large aluminum D-rings at the ventral, sternal, and dorsal attachment points keep the harness lightweight, and also fit multiple carabiners.
- Molded gear loops with high impact, cold resistant, polypropylene core provide easy gear stowage and retrieval. Additional tool loops are provided at the waist and legs.
- Compatible with CMC SkySaddle™ and ATOM Chest Ascender Kit (sold separately).

Color: Black | Weight: 2.25 kg (4.97 lb)

Item #	Size	Waist	Leg Loop Circumference
202227	Small	66–81 cm (26–32 in)	51-91 cm (20-36 in)
202228	Medium	81–107 cm (32–42 in)	51-91 cm (20-36 in)
202229	Large	107–122 cm (42–48 in)	51-91 cm (20-36 in)



ATOM™ Global Quick Harness

FULLY FEATURED FOR EASE OF USE AND VERSATILITY



NFPA 2500 CLASS III
LIFE SAFETY HARNESS



EN 361; EN 358; EN 813



ANSI Z359.11

CSA Z259.10

Configured with enhanced features for efficient donning and positioning, the ATOM Global Quick Harness is designed for technicians working in challenging vertical environments. It is certified to European and North American standards and has all the features of the ATOM Global Harness while swapping-in aluminum side attachment points and quick-connect buckles at the legs and left shoulder for greater ease of use.

Features

- Quick-connect buckles at the legs and left shoulder make donning quick and efficient.
- Aluminum side attachments at the waist stow away until needed for work positioning.
- Large aluminum D-rings at the ventral, sternal, and dorsal attachment points keep the harness lightweight, and also fit multiple carabiners.
- Molded gear loops with high impact, cold resistant, polypropylene core provide easy gear stowage and retrieval. Additional tool loops are provided at the waist and legs.
- Compatible with CMC SkySaddle™ and ATOM Chest Ascender Kit (sold separately).

Color: Black | Weight: 2.52 kg (5.56 lb)

Item #	Size	Waist	Leg Loop Circumference
202127	Small	66–81 cm (26–32 in)	51-91 cm (20-36 in)
202128	Medium	81–107 cm (32–42 in)	51-91 cm (20-36 in)
202129	Large	107–122 cm (42–48 in)	51-91 cm (20-36 in)



ATOM™ Chest Ascender Kits

CMC offers multiple options for installing a chest ascender on the ATOM Harness. For the CT HC and Petzl Croll ascenders, CMC recommends using the ATOM Chest Ascender Kit, which includes an ascender strap and quick link. For the Harken Ninja MultiAscend, CMC recommends using the ATOM MultiAscend Strap. Visit our website for installation instructions.

Features

- ATOM Chest Ascender Kit is compatible with CT Chest Ascender HC and Chest Ascender+, and Petzl Croll Ascenders sizes small and large. Includes one Ascender Loop and one 8mm Delta Quick Link.
- ATOM MultiAscend Strap is compatible with the Harken Ninja MultiAscend. Includes a single strap which is the only additional item needed for installation. See Hardware Section for details.

Item #	Description	Weight
343500	ATOM Chest Ascender Kit	95 g (.21 lb)
343580	ATOM MultiAscend Strap	11 g (.03 lb)



ATOM Chest Ascender Kit (Left) and ATOM MultiAscend Strap (Right). Chest ascender sold separately.

SkySaddle™



This robust work seat is designed to reduce fatigue and increase long-term comfort. It integrates with our ATOM Harness, and is compatible with most rope access harnesses on the market.

Recommended for
Rope Access | Work Positioning

Features

- Internal aluminum frame with rolled edges for strength and durability.
- Wide seat offers stability, comfort, and allows a standing work position.
- Rigid sides prevent straps from contacting user's body.
- Suspension straps adjust easily in both directions.
- Breathable D3 fabric with molded air channels for all-day comfort.
- Gear loop attachments on sides and bottom (5 total).
- Compatible with the ATOM Harness Series and most other rope access harnesses.
- Can be attached to the harness while suspended and quickly stows on the back when not in use when standing, walking, or during transitions.

Color: Gray/Black

Item #	Size	Weight
202690	53 x 17 x 15 cm (21 x 6.5 x 6 in)	1.72 kg (3.8 lb)



ATOM™ Sit Harness



NFPA 2500 CLASS II
LIFE SAFETY HARNESS

Leveraging the technology of CMC's ATOM Harness Series, the ATOM Sit Harness is designed for maximum comfort, versatility, and support. This lightweight sit harness allows the user to work freely and efficiently.

Recommended for

Rope Access | Industrial Rescue | Work Positioning
Law Enforcement | Military Operations

Features

- Ventral steel D-ring offers a robust, low-profile attachment point that can fit multiple carabiners.
- Cobra quick-connect leg buckles make donning quick and efficient.
- Low-profile soft attachments at the sides and rear for positioning.
- Molded gear loops with high impact, cold resistant, polypropylene core provide easy gear stowage and retrieval.
- Workseat attachment points for CMC SkySaddle™ (sold separately).

Color: Black | Weight: 1.56 kg (3.45 lb)

Item #	Size	Waist	Leg Loop Circumference
202322	Small	66–81 cm (26–32 in)	51-91 cm (20-36 in)
202324	Medium	81–107 cm (32–42 in)	51-91 cm (20-36 in)
202325	Large	107–122 cm (42–48 in)	51-91 cm (20-36 in)



**CUSTOMIZE YOUR
ATOM™ SIT HARNESS**

ATOM™ Chest Harness



NFPA 2500 CLASS II
LIFE SAFETY HARNESS*

This modular chest unit transforms the ATOM Sit Harness or ATOM Build Your Own Sit Harness into a full body NFPA Class III Life Safety Harness. The ATOM Chest Harness is quickly and easily installed for team members transitioning from needing edge protection to working on rope.

Recommended for

Fire Rescue | SAR | Law Enforcement | Work Positioning

Features

- Transforms ATOM Sit Harness or ATOM BYO Sit Harness into a full body NFPA Class III Life Safety Harness.
- Sternal and dorsal steel D-rings provide robust, low-profile attachment points that can fit multiple carabiners.
- Compatible with the ATOM Chest Ascender Kit, which allows a variety of chest ascenders to be added or swapped out.
- Fully integrates to transfer the load from chest attachment points to the Sit Harness, increasing comfort in a vertical lift.
- Allows teams to utilize ATOM Sit Harness comfort and mobility until a full body harness is preferred for working on rope.

Color: Black | Weight: .85 kg (1.87 lb)

*When combined with the ATOM™ Sit Harness



Item #	Size
202363	One Size Fits Most

Ranger Harness™



NFPA 2500 CLASS II
LIFE SAFETY HARNESS

This popular full-featured harness combines the lightness of a climbing harness with the utility of a rescue harness.

Recommended for

SAR | Fire Rescue | Law Enforcement | Rappelling

Features

- Low-profile, flexible waist belt and leg loops are lined with breathable fabric.
- Ventral aluminum D-ring offers a robust, lightweight attachment point that can fit multiple carabiners.
- Low-profile soft attachments at the sides and rear for positioning.
- Compatible with most chest harnesses.
- Flexible gear loops offer low-profile gear stowage when working in tight or confined spaces.
- Comfortable support while suspended along with optimum packability



Color: Black | **Weight:** 794 g (1.7 lb)

Item #	Size	Waist
202382	Small	66–81 cm (26–32 in)
202384	Medium	81–107 cm (32–42 in)
202385	Large	107–122 cm (42–48 in)

Ranger Quick Harness™



NFPA 2500 CLASS II
LIFE SAFETY HARNESS



The same features as the Ranger Harness with quick-connect buckles added on the leg loops for fast and efficient use.

Color: Black | **Weight:** 872 g (1.9 lb)

Item #	Size	Waist
202392	Small	66–81 cm (26–32 in)
202394	Medium	81–107 cm (32–42 in)
202395	Large	107–122 cm (42–48 in)

Ranger Chest Harness™



Ideal for backcountry operations, this chest harness can be worn comfortably all day.



Features

- Padded shoulder straps with breathable fabric.
- Connects to most sit harnesses with included Delta Quick Link and connector strap.
- Four adjuster buckles for optimal fit.
- Ideal for remote operations.
- Designed for all-day comfort.

Item #	Color	Chest	Weight
202315	Black	Up to 132 cm (52 in)	680 g (1.5 lb)



Outback™ Convertible Harness

BUILT FOR BACKCOUNTRY OPERATIONS



ASTM F1772

A lightweight modular system for fast-moving technical teams in remote areas. Certified to EN standards and tested to ASTM standards, the Outback Convertible Harness meets the strength requirements for a versatile mountaineering harness capable of rescue, rope access, climbing, and tactical or military operations. Its patent-pending integration lets users configure the harness for the task at hand and share components in the field. Every team member wears the belt, edge personnel add leg loops, and vertical technicians get the full ensemble. The Outback Convertible Harness is globally certified, highly configurable, and fully-featured for challenging backcountry operations.



Waist Belt



Waist Belt + Leg Loops



Chest Harness



Chest Ascender Kit



Carry Pouch



Gear Loop



Full Harness System

Item #	Option	Size	Waist Circumference	Weight	Color
202142	Sit Harness, Small	Small	74-84 cm (29-33 in)	620 g (1.37 lb)	Brown/Black
202143	Sit Harness, Medium	Medium	84-94 cm (33-37 in)	635 g (1.40 lb)	Brown/Black
202144	Sit Harness, Large	Large	94-104 cm (37-41 in)	655 g (1.45 lb)	Brown/Black
202145	Sit Harness, X-Large	X-Large	104-114 cm (41-45 in)	660 g (1.46 lb)	Brown/Black
202146	Chest Harness	Adjustable	N/A	520 g (1.15 lb)	Brown/Black
343020	Chest Ascender Kit	Rope 9-11 mm	N/A	132 g (.29 lb)	Black
430826	Carry Pouch	Volume 2.3 L (140 ci)	N/A	170 g (.37 lb)	Brown
202150	Gear Loop	One Size	N/A	32 g (.07 lb)	Black



How to convert the Outback from belt to sit harness

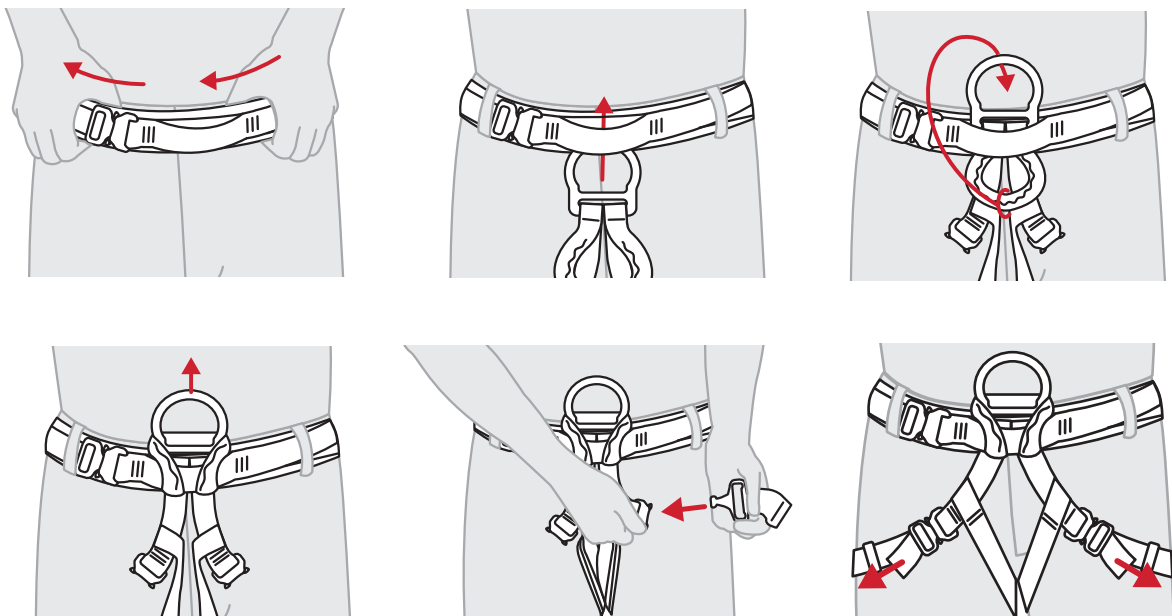

Confined Space Harness™



NFPA 2500 CLASS III
LIFE SAFETY HARNESS

ANSI Z359.11

Designed for confined space, industrial rescue, and USAR operations, the Confined Space Harness offers a high degree of functionality and comfort, even during a vertical shoulder lift.



Features

- Integrated mesh vest keeps shoulder straps in place.
- Vest includes radio pocket, multi-use pocket, and zippered mesh gas monitor pocket.
- Rated attachments at ventral, sternal, dorsal, and rear waist.
- Shoulder pick-off points for confined space vertical lift.
- Large front D-ring at waist for comfortable rappels.
- Hand grip on back assists in retrieval from tight spaces.
- Two ANSI Z359.11 certified lanyard parking loops at waist.
- Molded waist padding with integrated lumbar support.
- Breathable fabric with contoured air channels for greater comfort and lighter weight.

Color: Black/Blue | **Weight:** 3.7 kg (8.1 lb)

Item #	Size	Waist
202162	Small	66–82 cm (26–32 in)
202164	Medium	82–107 cm (32–42 in)
202165	Large	107–122 cm (42–48 in)

Helitack Harness™



NFPA 2500 CLASS III
LIFE SAFETY HARNESS

Designed with extensive input from air crews, the Helitack Harness provides a high level of comfort, safety, and versatility.



Features

- Integrated mesh vest keeps shoulder straps in place.
- Removable pockets for HEED bottle, radio, and other items.
- Front waist sewn loop provides a ventral attachment point.
- Rear waist D-ring attachment point supports travel restraint.
- Sternal and dorsal attachment points allow flexible hoisting.
- Sewn web loops at shoulders for accessory attachment.
- Orange mesh vest and reflective strips increase visibility.
- Two 10mm Delta Quick Links included.
- Pass-through quick-connect steel buckles on leg loops.
- Multiple gear loops for racking equipment.

Color: Black/Orange | **Weight:** 3.6 kg (7.9 lb)

Item #	Size	Waist
202922	Small	66–76 cm (26–34 in)
202924	Medium	76–112 cm (30–44 in)
202925	Large	107–122 cm (42–48 in)

Tactical Rappel Harness™



A low profile, all-black harness with black buckles that can be worn continuously or donned quickly when needed.



Recommended for
Law Enforcement | Military Operations | SAR | Rappelling

Features

- Web attachment point at front waist for silent connections.
- Padded leg loops with breathable fabric.
- Removable harness pouch (4.75 in W x 5 in H x 2.5 in D) holds accessories and up to 6.5 m of cord.
- Gear loop on left side.
- One-size fits most.

Item #	Color	Waist	Weight
202407	Black	43-142 cm (17-56 in)	780 g (1.5 lb)

Utility Harness



NFPA 2500 CLASS II
LIFE SAFETY HARNESS

This simple one-size-fits-most harness has a small footprint for easy stowage.



Recommended for
Fire Rescue | Industrial Rescue | SAR | Law Enforcement

Features

- Steel D-ring attachment point at front waist.
- Easily adjustable for wide range of fit.
- Low-profile, packable design.
- One-size fits most.

Item #	Color	Waist	Weight
202306	Black	Up to 142 cm (56 in)	822 g (1.8 lb)

Pronto Evac™ Harness



Originally designed for ski lift rescue operations, the Pronto Evac Harness is ideal for situations where quick and easy donning is essential including self-evacuation and victim rescue at height.

Recommended for
Ski Lift Evacuation | Victim Rescue

Features

- Color-coded leg straps simplify donning.
- Side-release quick connect buckles at waist and legs.
- The victim does not have to step into harness.
- Attachment point doubles as handle to aid in positioning.
- Fits anyone from small children to large adults.



Color: Black/Gray/Red

Item #	Waist	Weight
202320	30-157 cm (12-62 in)	808 g (1.8 lb)



Lifesaver Victim Harness™



NFPA 2500 - CLASS II
LIFE SAFETY HARNESS

Attaches quickly and securely regardless of where or how the victim is positioned.



Recommended for
Fire Rescue | Industrial Rescue | SAR

Features

- Color-coded leg straps simplify donning.
- Steel Snap-Hook Buckles at waist and legs make for a fast, secure connection.
- The victim does not have to step into harness.
- The attachment point doubles as handle to guide positioning.
- Compact design includes integrated carry bag.
- Fits anyone from small children to large adults.

Color: Black/Red /Blue

Item #	Waist	Weight
202405	58-157 cm (23-62 in)	1.3 kg (2.9 lb)

Lifesaver Victim Chest Harness™



Converts the Lifesaver Victim Harness or Pronto Evac Harness into a full-body evacuation harness for vertical lifts or whenever upper body support is needed. Must be used with seat harness.



Pictured with
Lifesaver Victim
Harness and carabiner
(sold separately).

Recommended for
Fire Rescue | Industrial Rescue | SAR

Features

- Easily attached to victim under all conditions.
- Provides upper body support in a vertical lift.
- Padded for victim comfort.
- Easily adjustable for wide range of fit.
- Ideal for lifting patients in confined space scenarios.

Color: Red

Item #	Chest	Weight
202404	Up to 170 cm (67 in)	964 g (2.1 lb)

Uniform Rappel Belt™



NFPA 2500
ESCAPE BELT

Designed for everyday wear, this belt has the necessary features for an emergency rappel or belay. Certified to NFPA standards.



Recommended for
Fire Rescue | SAR | Law Enforcement | Military Operations

Features

- V-ring attachment point is secured out of way until needed using a hook and loop fastener. Excess belt tail is also secured.
- Reversible design allows the belt to be flipped on the body for right or left hand tightening and adjustment.
- Constructed with mil spec webbing that includes tracer thread.

Color: Black | **Weight:** 255 g (.6 lb)

Item #	Size	Waist
202422	Small	66–81 cm (26–32 in)
202423	Medium	76–91 cm (30–36 in)
202424	Large	86–107 cm (34–42 in)
202425	X-Large	102–122 cm (40–48 in)

Trench Work-Rescue Belt™



A low-profile belt designed for work or rescue operations in or around a trench.

Recommended for
Trench Rescue | Work Positioning

Features

- Aluminum quick-connect buckle with integrated stainless D-ring.
- The buckle is easy to open or close when wearing gloves, but requires a two-finger release and doesn't open when loaded.
- Aluminum D-ring rear connection can be used to restrict travel.
- Constructed of multiple layers of web to limit movement of the rear D-ring and increase utility when carrying tools.
- One size fits most. Adjusts to fit over turnouts.

Cobra-D Uniform Rappel Belt™



NFPA 2500
ESCAPE BELT

Offering the same certified emergency rappel and belay functionality as our Uniform Rappel Belt, this belt has the added convenience of a quick-connect buckle.

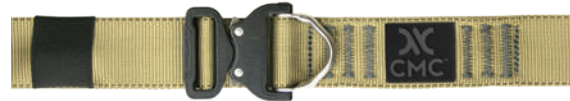

Recommended for
Fire Rescue | SAR | Law Enforcement | Military Operations

Features

- Aluminum quick-connect buckle with stainless steel D-ring requires two-finger release and will not open if loaded.
- One size fits most. Web Keeper secures excess web.

Waist: 66–122 cm (26–48 in) | **Weight:** 294 g (.6 lb)

Item #	Color
202400	Black
202590	Coyote Tan



Item #	Color	Weight
203734	Black	397 g (.88 lb)

SEE MORE

Fulcrum Escape™ Belt

Fire-resistant, easy to use, NFPA rated. See Page 93.



HARNESSES & BELTS

Ladder Belt



NFPA 2500
LADDER BELT

A wide supportive belt for firefighting operations with an added tether that extends the connection length to reach the ladder rung.



Comfortable
and easy to don.

Recommended for Fire Ground Operations

Features

- Tether extends length of connection up to 425 cm (16.75 in) to reach the ladder rung.
- Auto-locking ProSeries XL carabiner included.
- Wide padding for added comfort.
- Snap-hook closure for easy donning.

Color: Red/Black | **Weight:** 964 g (2.1 lb)

Item #	Size	Waist*
202442	Small/Medium	66–86 cm (26–34 in)
202444	Large/X-Large	86–107 cm (34–42 in)
202446	XX-Large	107–127 cm (42–50 in)

*Measure waist with turnouts on

K9 ProSeries® Rappel Harness



A lightweight, adjustable harness that can be easily packed into the field. Extensively tested, proven and trusted worldwide by K9 teams for comfort, security, and ease of use.



Features

- Durable nylon panels with breathable fabric on the inside.
- Stowaway rear-lift assembly fits around dog's back legs.
- 5 ANSI rated quick-connect buckles for efficient deployment.
- Soft-loop main connection point suspends dog in a comfortable position.
- Large molded rubber handle aids in lifting and positioning.
- Rear attachment point for connecting a lead.
- Elastic loops for securing a light stick.
- One size will fit most rescue/tactical-use canines.

Item #	Color	Weight
890255	Black	930 g (2 lb)

Dualcom™ Radio Harness



This advanced dual-communication radio chest harness keeps communication devices and field necessities close at hand.

Features

- Three adjustable holsters accommodate two variable-size radios and a GPS unit or spare battery.
- Two side-zip pockets for notebook, large smartphone, field guide, pocket knife or other instruments.
- 20 x 23 cm (8 x 9 in) main compartment holds large map, mini electronic tablet, trauma scissors, spare batteries, etc.
- Internal niche pocket for dispensing flagging tape through external grommet.
- Front attachment loop for pocket light.
- Antenna keeper on left shoulder strap.
- Two front pen sleeves.
- Made of 1,000-denier Cordura® nylon.

Size: 22 x 28 cm (8.75 x 11 in)

Item #	Color	Weight
240048	Black/Gray	445 g (.98 lb)

ProSeries® Radio Harness



A full-featured radio harness made for long wear under rugged conditions.

Features

- Stabilizing back straps for increased comfort.
- Adjustable pocket fits wide range of radios.
- Spare battery pocket has hook-and-loop attachment point.
- Outside pocket holds a pen and folding knife or multi-tool.
- Pocket flap has a place to clip a speaker mic.
- Large panel pocket with zipper closure holds notepad, folded maps, or extension antenna.
- Antenna keeper on left shoulder strap.
- Made of 1,000-denier Cordura® nylon.

Item #	Weight
240029	300 g (.66 lb)

Radio Holster

This versatile holster can be carried on a belt, a harness, or a backpack shoulder strap.



Features

- Secures to a belt with a loop slot, or to a shoulder strap with dual hook-and-loop straps.
- Easily adjustable radio pocket holds most radios while allowing access to knobs, front-mounted keypads, and displays.

Item #	Weight
240027	85 g (.19 lb)





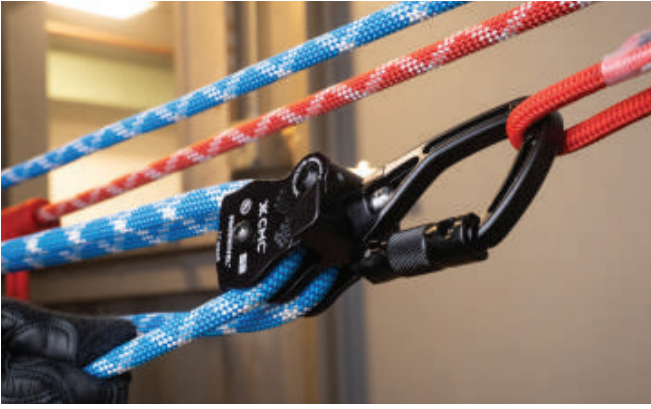

HARDWARE



NEW

CAPTO™

EASY HAULING AND ASCENDING WITH FORCE-LIMITING OVERLOAD PROTECTION



**NFPA 2500 GENERAL USE
ROPE GRAB & PULLEY**



**EN 12841/B, EN 567, EN 12278
(11 MM CAPTO ONLY)**

PATENTED

CAPTO is an intuitive device that combines a multi-functional rope grab, high-efficiency pulley, and integrated becket for easy hauling and ascending. Built around an innovative V-groove Cam, CAPTO is designed to handle rescue loads while providing force-limiting overload protection.

Features

- Combines a rope grab, pulley, and becket in a compact device for hauling and ascending.
- Incorporates a force-limiting V-groove Cam for overload protection. Visit CMC's website to see force-limiting data across industry ropes.
- Installs quickly and easily on tensioned and un-tensioned lines.
- Opens one-handed and gives simultaneous access to components.
- Builds efficient M/A systems, rapidly progresses from a 3:1 to a 5:1.
- Releases and resets easily, even after high loading, making it ideal for rescue applications.
- Travels down rope in vertical systems to reset the haul field.
- Allows installation of an accessory loop for remote resets and device stowage. CMC recommends using the CAPTO Soft Shackle (below).
- Provides an integrated becket for attaching M/A components, piggy-back systems, lanyards, and foot loops.
- Replaces multiple devices in one, streamlining training and operations.

Dimensions: 15.0 x 7.1 x 3.1 cm (5.9 x 2.8 x 1.2 in)

Item #	Rope Size	Color	Weight	Certifications
336011	10.5–11 mm (7/16 in)	Gray	513 g (1.13 lb)	NFPA 2500 (G) Rope Grab NFPA 2500 (G) Pulley, 36 kN EN 12841:2006/B, 200 kg EN 567:2013 EN 12278:2007, 36 kN
336013	12.5–13 mm (1/2 in)	Red	508 g (1.12 lb)	NFPA 2500 (G) Rope Grab NFPA 2500 (G) Pulley, 36 kN

Pulley strength testing performed using the CAPTO becket as pulley attachment point.



CAPTO™ Soft Shackle

The ideal companion for every CAPTO. This impressively strong and durable soft shackle installs through the CAPTO cam axle to provide an additional attachment point for smooth remote resets and easy device stowage on a harness or gear rack.

Item# | 293005



CAPTO APPLICATIONS



Hauling



Simple 3:1

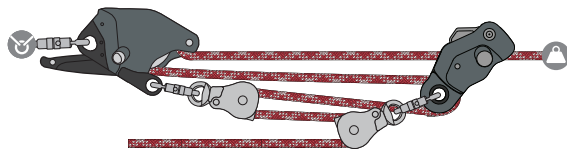

Simple 5:1

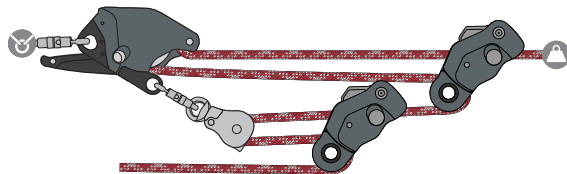

Compound 9:1



Complex 5:1



Ascending

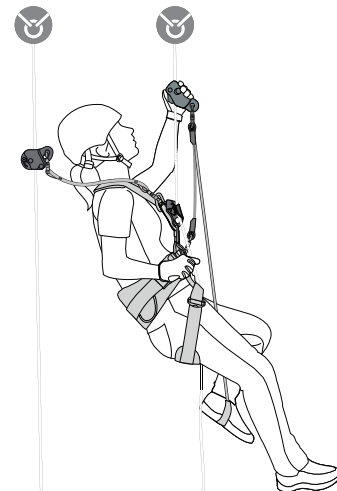

Ascending

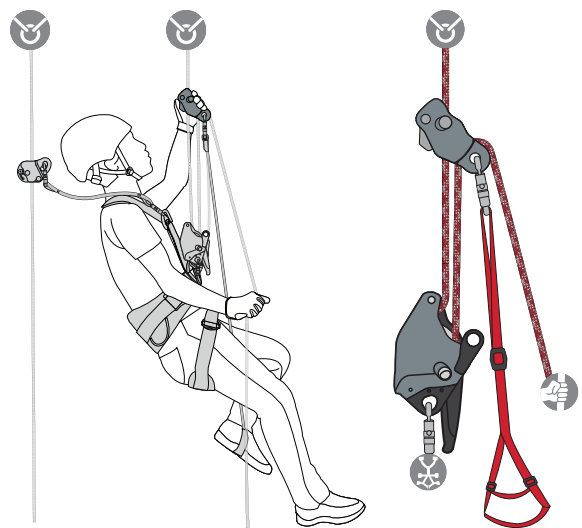

Rapid Ascent and Descent (RAD)



HARDWARE

CMC CLUTCH™ by Harken™

THE LATEST EVOLUTION IN RESCUE AND ROPE ACCESS HARDWARE



NFPA 2500 GENERAL USE
DESCENT CONTROL,
BELAY, & PULLEY



ANSI
Z359.4



EN 12841/C, EN 341/2A,
EN 15151-1/8
(11 MM CLUTCH ONLY)

PATENTED

The highly versatile CLUTCH allows technical rope professionals to do more with less. This wearable, multi-purpose tool is designed for intuitive and efficient operation, ease of use, and optimal control. The CLUTCH moves seamlessly between anchor-based systems and personal use, making it well-suited to a multitude of rigging operations.

Features

- Single tool for hauling, lowering, personal descent, ascending, belaying, and running Twin Tension Rope Systems (TTRS).
- Instantly transitions between hauling and lowering or ascent and descent without having to transfer the load.
- Up to 38% higher efficiency than a cam-style descender.
- Designed with force-limiting features to protect the system in overload situations and limit impact loads when arresting a fall.
- Built-in Anti-Panic brake increases operational safety.
- Comprised of all metal parts for lightweight durability.
- Capable of lowering a two-person load without requiring a secondary friction carabiner.
- Allows main and belay lines to be mirrored and nested in Double CLUTCH technique (controlled by single operator).
- Replaces 8 pieces of traditional equipment: pulley, rescue rack, anchor plate, load release strap, prusik cord, and 3 carabiners.
- Combines with CMC's G11 to build NFPA G-Rated systems with 11 mm rope, reducing overall volume and weight.



Components

- Stainless steel ratcheting and rotating sheave provides efficient and audible progress capture.
- Rope loading and unloading is secured with a double-latched side plate independent from the attachment point.
- Machined aluminum chassis clad with stainless steel wear guards ensures light weight and durability.
- Integrated becket allows for the direct connection of mechanical advantage system components.
- Control handle has a large sweet spot for smooth, progressive lowering and descent control.
- Included screw can be installed in sideplate to pre-rig systems.



Item #	Rope Size	Color	Dimensions	Max Load	3 Sigma MBS	Weight
335011	10.5–11 mm (7/16 in)	Gray	20.8 x 11.2 x 4.7 cm (8.2 x 4.4 x 1.9 in)	272 kg (600 lb)	Pulley: 40 kN (8,992 lbf) Becket: 22 kN (4,946 lbf)	836 g (1.84 lb)
335013	12.5–13 mm (1/2 in)	Red	20.8 x 11.2 x 4.7 cm (8.2 x 4.4 x 1.9 in)	272 kg (600 lb)	Pulley: 40 kN (8,992 lbf) Becket: 22 kN (4,946 lbf)	816 g (1.80 lb)

SEE MORE

Double CLUTCH TTRS Kit

Comprehensive kit for best practice twin tension hauling and lowering using the CLUTCH. See Page 140.

CLUTCH APPLICATIONS



Personal Use

The CLUTCH has a high-efficiency rotating ratcheting sheave that helps technicians move on rope with less fatigue and fewer transitions. The ergonomic control handle has a large sweet spot for smooth descents and the Anti-Panic Brake provides additional safety. Designed with an independent attachment point, the CLUTCH can be loaded and unloaded without risk of being dropped. Its all-metal parts deliver lasting durability in harsh conditions.

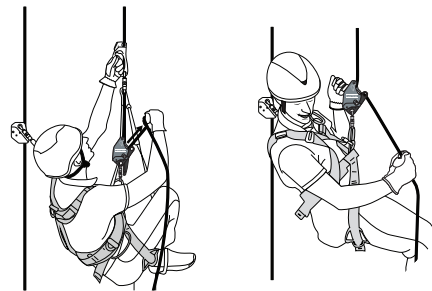

Easy Ascent

Smooth Descent



Anchor-Based Systems

The CLUTCH replaces multiple pieces of equipment, streamlining training and operations. It quickly transitions between lowering and raising without having to transfer the load. Easy to rig and operate, it allows a single operator to control two devices for better shared tension in Double CLUTCH Technique. The integrated becket enables rapid installation of M/A components and the built-in safety features provide force-limiting overload protection.

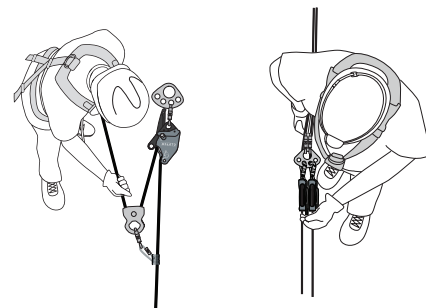

Efficient Hauling

Controlled Lowering



NEW

SQUID™ Rig Plate



NFPA 2500
GENERAL USE / TECHNICAL USE



CE, PPE-R/RFU 11.114

SQUID is an innovative solution for twin tension rope systems (TTRS) and other load-sharing applications. SQUID simplifies the technique of bringing two devices together for side-by-side operation. Its multi-planar design optimizes device alignment, promotes smooth raising and lowering, and enables single operator control for better shared tension.

The SQUID's attachment points allow components to move freely and orient toward the load, reducing the risk of binding and shifting. The spacing between attachment points is ideally set for easy loading and unloading of connected hardware devices. Strong, solid, and compact, SQUID supports a variety of connection methods and facilitates versatile redundant rigging across multiple disciplines.

Features

- Multi-planar rigging plate with perpendicular attachment points.
- Optimizes device alignment for twin tension rope systems (TTRS).
- Enables single operator control for better shared tension.
- Functions as a master point for litter bridals and cross-hauls.
- Promotes smooth loading / unloading of connected hardware.
- Allows components to move freely and orient toward the load.
- Reduces shifting / extension in the event of line or anchor failure.
- Aligns secondary points for high strength and easy load sharing.
- Supports a variety of connection methods for versatile rigging.
- Provides large collection points for building redundant systems.
- Simple and solid aircraft grade aluminum with no moving parts.
- Strong, compact, and lightweight for multiple applications.

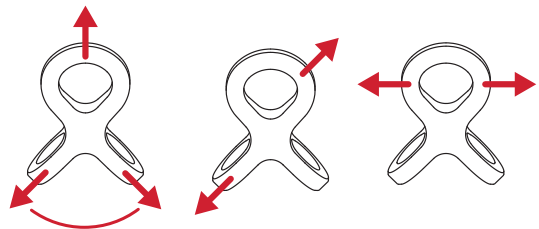
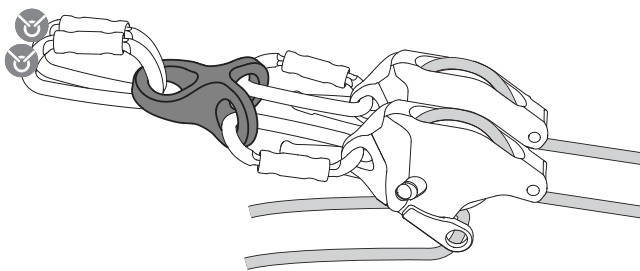

NFA General Use Configuration
MBS 45 kN (10,116 LBF)

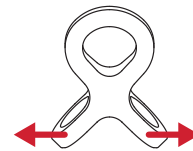

NFA Technical Use Configuration
MBS 27.7 kN (6,227 lbf)

Weight: 240 g (.52 lb) | **Material:** Aluminum

Item #	Min Hole Diameter	Color
300020	Primary - 3.6 cm (1.42 in) Secondary - 2.7 cm (1.07 in)	Black

MPD™ (Multi-Purpose Device)

A HIGH-EFFICIENCY PULLEY WITH AN INTEGRATED ROPE GRAB AND MORE



NFPA 2500 GENERAL USE / TECHNICAL USE
DESCENT CONTROL, BELAY, & PULLEY

PATENTED

The MPD is a versatile tool that allows rescue and rope access professionals to transition from lowering to raising without changing hardware. It can be used as a lowering device on main and belay lines or twin tension systems, and then rapidly converted to a raising system without switching or replacing hardware. This combination of features in a single device reduces weight, simplifies training and on-scene rigging, expedites operations, and increases user safety.

Features

- Industry leading 90% efficiency in a 3:1 haul system.
- Functions as a brake for lowering and a ratcheting pulley for raising.
- Variable-friction control for rescue systems and rappels.
- High-efficiency pulley with integrated rope locking mechanism.
- Built-in becket for more efficient rigging of pulley systems.
- Allows main and belay lines to be mirrored or twin-tensioned.
- Rapidly converts to retrieval line in confined space operations.
- Available for 13 mm (1/2 in) rope and 11 mm (7/16 in) rope.

Weight: 1.2 kg (2.6 lb)

NFPA Rating (Pulley): General Use

3 Sigma MBS Pulley: 46 kN (10,341 lbf)

Item #	Rope Size	Color	NFPA Rating
333000	13 mm (1/2 in)*	Red	General Use
333010	11 mm (7/16 in)**	Slate	Technical Use

*13 mm version designed for use with 12.5 – 13 mm rope. Rope used for certification rounded up to 13 mm per NFPA 2500.

**11 mm version designed and tested with 11 mm rope. 11 mm model is certified to NFPA Technical Use for descent control and belay.



HARDWARE



NEW

ProSwivel™ Pulley



NFPA 2500
GENERAL USE / TECHNICAL USE

PATENTED

CMC ProSwivel Pulleys are time-tested, made in the USA, and brought to you by two companies committed to quality and service. Manufactured in partnership with Rock Exotica, CMC ProSwivel Pulleys combine a swivel and pulley into one tool with a double-action sideplate for easy loading and unloading. Their high efficiency, compact size, and ability to rotate under load makes them an excellent choice for mechanical advantage systems. They also work well in combination with high anchors, tripods, and redirects. Available in sheave sizes ranging from 1.1 to 2.6 inches, our expanded line has plenty of options for selecting the best pulley for the job.

Features

- New models available including efficient 2" pulleys and lightweight 1.1" double pulleys.
- Patented, USA Made, time-tested, and proven as the original swivel pulleys.
- Combined swivel & pulley reduces system length, allowing more travel.
- Pivoting sideplate allows rope loading without disconnecting from anchor.
- Double-action detent button prevents accidental opening of the sideplate.
- Sheave is mounted on sealed ball bearings for maximum efficiency.
- Rotating swivel aligns rope with the direction of pull.
- Swivel can be secured using rope, web, or carabiners.
- Ergonomic design for anchoring and loading with one hand.
- CNC machined for optimal strength & weight.
- Prusik minding options facilitate progress capture.
- Compatible with rope up to 13 mm (1/2 in).
- 1.5" PMP SS Pulley is compatible with rope or wire cable.
- Ideal for rescue, work at height, and tree care.

NOTE: Do not load only one side of a double-sheave pulley.



300343



300433



300431



300432



300430



300437



300438



300436

Item #	Model	Weight	Pulley Type	Sheave Material	Height x Width	Color	NFPA Rating	3 Sigma MBS
300434	1.1" PMP Single Swivel Pulley	147 g (.32 lb)	Single	Aluminum	112 x 51 mm (4.4 x 2 in)	Bronze/Slate	Technical	22 kN (4,946 lbf)
300433	1.1" PMP Double Swivel Pulley	245 g (.54 lb)	Double	Aluminum	112 X 51 mm (4.4 X 2.0 in)	Bronze/Slate	Technical	22 kN (4,946 lbf)
300431	1.5" Single Swivel Pulley	261 g (.58 lb)	Single	Aluminum	135 X 63 mm (5.3 X 2.5 in)	Bronze/Slate	General	36 kN (8,093 lbf)
300432	1.5" Double Swivel Pulley	415 g (.91 lb)	Double	Aluminum	160 X 63 mm (6.3 X 2.5 in)	Bronze/Slate	General	36 kN (8,093 lbf)
300430	1.5" PMP SS Single Swivel Pulley	331 g (.73 lb)	Single	Stainless	148 x 76 mm (5.8 x 3 in)	Bronze/Slate	General	36 kN (8,093 lbf)
300437	2.0" PMP Single Swivel Pulley	349 g (.77 lb)	Single	Aluminum	148 X 76 mm (5.8 X 3 in)	Bronze/Slate	General	36 kN (8,093 lbf)
300438	2.0" PMP Double Swivel Pulley	585 g (1.29 lb)	Double	Aluminum	180 X 76 mm (7.0 X 3 in)	Bronze/Slate	General	36 kN (8,093 lbf)
300436	2.6" PMP Single Swivel Pulley	841 g (1.85 lb)	Single	Aluminum	191.3 X 92.5 mm (7.53 X 3.62 in)	Bronze/Slate	General	70 kN (15,737 lbf)



NEW

ProSwivel™ SwivaBiner



NFPA 2500
TECHNICAL USE

PATENTED

The SwivaBiner combines a swivel, pulley, and carabiner into a single compact device with a double-detent sideplate that opens while the pulley is still attached to the anchor. Teaming up with Rock Exotica, CMC offers a single and double sheave SwivaBiner each certified to NFPA standards. They are an excellent option for mechanical advantage systems for hauling and ascending, and they work well in combination with high anchors, tripods, and redirects. The SwivaBiner is patented, time-tested, made in the USA, and brought to you by two companies committed to quality and service.

Features

- Combined swivel, pulley, & carabiner reduces system length, allowing more travel.
- Auto-locking integrated carabiner is quick, convenient, and easy to use.
- 1.1 inch sheave is compact and lightweight.
- Pivoting sideplate allows rope loading and unloading without disconnecting from the anchor.
- Double-action detent button prevents accidental opening.
- Sheave is mounted on sealed ball bearings for maximum efficiency.
- Rotating swivel aligns rope with the direction of pull.
- Ergonomic design for anchoring and loading with one hand.
- CNC machined for optimal strength & weight.
- Prusik minding faceplate prevents entanglement.
- Double sheave pulleys equipped with integrated becket.
- Compatible with rope up to 13 mm (1/2 in).
- Ideal for rescue, work at height, and tree care.



Item #	Model	Weight	Pulley Type	Sheave Material	Height x Width	Color	NFPA Rating	3 Sigma MBS
300435	1.1" PMP SwivaBiner Pulley	200 g (.44 lb)	Single	Aluminum	112 x 51 mm (4.4 x 2 in)	Black	Technical	22 kN (4,946 lbf)
300439	1.1" PMP SwivaBiner Double Pulley	298 g (.66 lb)	Double	Aluminum	112 x 51 mm (4.4 x 2 in)	Black	Technical	22 kN (4,946 lbf)

NOTE: Do not load only one side of a double-sheave pulley.

CSR2 Pulley



NFPA 2500
GENERAL USE



EN 12278

PATENTED

Strong and smooth, the CSR2 (Confined Space Rescue) Pulleys are ideal for building mechanical advantage systems to support confined space and rope rescue operations, as well as industrial and rope access applications. When paired together and rigged for raising and lowering, the CSR2 pulleys allow safe release under load and efficient vertical hauling.

Features

- A proprietary locking system eliminates a toothed cam, so the pulley can be safely released when under load.
- Integrated thrust-bearing swivel reduces torque.
- High-strength aluminum side plates and sheave.
- High-efficiency sealed ball bearings.
- A side-located becket allows maximum lift height and full retraction of system.
- Compatible with 11 mm to 13 mm life safety ropes.
- Removable becket cover facilitates changing lifelines with sewn terminations.



Item #	Type	Color	3 Sigma MBS	Sheave Tread Size	Weight
300343	CSR2 Pulley	Red/Gray	40 kN (8,992 lbf)	57 x 13 mm (2.25 x .5 in)	1.1 kg (2.5 lb)
300342	CSR2 Double	Gray	40 kN (8,992 lbf)	57 x 13 mm (2.25 x .5 in)	.68 kg (1.5 lb)

SEE MORE

CSR2 Pulley System

Pre-rigged and fully assembled for immediate use with CMC Static-Pro and ProSeries Carabiners. **See Page 139.**

Kootenay Ultra Pulley



NFPA 2500
GENERAL USE

The Kootenay Ultra Pulley is an impressively versatile pulley for knot-passes and high-strength tie-offs. For high lines, the rigging holes allow for optimum separation of tag lines and hoist ropes for reeving variations. For English and Norwegian reeves, a greater spread between the hoist pulleys reduces the chance of inadvertent spinning of the load.

Features

- Separate rigging holes make rigging easier, prevent carabiners from binding, and allow optimum separation of tag lines and hoist ropes.
- Integrated sheave-lock pin is stowed in the axle and inserts easily into sheave-lock hole when needed for high-strength tie-offs.
- Facilitates management of air and communication lines when using an Artificial High Directional (AHD) in confined space rescue operations.
- High-efficiency sealed ball bearings. Strong, durable aluminum sheave.



Item #	Sheave	Color	3 Sigma MBS	Sheave Tread Size	Weight
300391	Aluminum	Orange	38 kN (8,543 lbf)	57 x 64 mm (2.25 x 2.5 in)	709 g (1.6 lb)



HARDWARE

Rescue Pulley

DESIGNED FOR USE WITH UP TO 13 MM ROPE



NFPA 2500
GENERAL USE

This compact, full-strength Prusik minding pulley is ideal for mountain rescue, swiftwater, and other technical applications where lightweight gear is critical. Compatible with rope diameter up to 13 mm (1/2 in)

Features

- Machined side plates vary in thickness to maximize strength-to-weight ratio.
- High-efficiency sealed ball bearings.
- Aluminum side plates protect rope.
- Extremely low-profile stainless steel axle assembly.
- Compact design reduces snagging on uneven surfaces.
- Double pulley has integrated becket.



Item #	Type	Color	3 Sigma MBS	Sheave Tread Size	Weight
300301	Single	Red	52 kN (11,690 lbf)	38 x 13 mm (1.5 x .5 in)	145 g (.32 lb)
300302	Double	Red	45 kN (10,116 lbf)	38 x 13 mm (1.5 x .5 in)	249 g (.55 lb)

NOTE: Do not load only one side of a double-sheave pulley.

ProTech™ Pulley

DESIGNED FOR USE WITH UP TO 11 MM ROPE



NFPA 2500
GENERAL USE

A compact, full-strength Prusik-minding pulley ideal for applications where weight is a significant consideration. Compatible with rope diameter up to 11 mm (7/16 in)

Features

- Machined side plates vary in thickness to maximize strength-to-weight ratio.
- High-efficiency sealed ball bearings.
- Aluminum side plates protect rope.
- Unique axle assembly delivers a smooth side plate and high strength.
- Compact design reduces snagging on uneven surfaces.
- Double pulley has integrated becket.



Item #	Type	Color	3 Sigma MBS	Sheave Tread Size	Weight
300501	Single	Sand	36 kN (8,093 lbf)	25 x 11 mm (1 x .44 in)	94 g (.2 lb)
300502	Double	Sand	36 kN (8,093 lbf)	25 x 11 mm (1 x .44 in)	156 g (.34 lb)

NOTE: Do not load only one side of a double-sheave pulley.

Enforcer Load Cell Kit



NFPA 2500
GENERAL USE

Packed with advanced features, this compact load cell monitors system forces up to 20 kN and logs drop tests in high resolution. Certified to NFPA General Use with multiple sampling modes and Bluetooth connectivity.

Features

- Compact design for in-line use with rope rigging systems.
- Large digital readout.
- Bluetooth connectivity with connection indicator.
- Lightweight machined aluminum construction.
- Swivel attachments diminish torsional and off-axis forces.
- Two sampling modes: slow for monitoring, fast for drop testing.
- Measures forces up to 20 kN.
- Reports measurements in kN, lbf, and kg.
- Kit includes Enforcer Load Cell, protective waterproof case, screwdriver, and two AAA batteries.



Item #	Color	3 Sigma MBS	Dimensions
300750	Black/Sand	36 kN (8,093 lbf)	203 x 51 x 38 mm (8 x 2 x 1.5 in)

NOTE: Not for use with steel cables or wire ropes.

SEE MORE

Enforcer App for iOS Devices

The Enforcer App brings greatly enhanced monitoring and reporting capabilities to the Enforcer Load Cell. Available for purchase in the Apple App Store.



Swivels



NFPA 2500
GENERAL USE

Our anodized aluminum swivels are available in two sizes. The use of a swivel can help prevent system lines from wrapping around one another and reduce spin caused by loading a free-hanging rope.

Rescue Swivel Features

- Lightweight, high strength, standard-size swivel for litter systems.
- Symmetrical holes accommodate multiple carabiners.

ProSeries Swivel Features

- Larger size is compatible with helicopter short-haul line equipment.
- Special bearing supports high loads without sustaining damage.



Item #	Model	Color	3 Sigma MBS	Length	Weight
300721	Rescue	Sand/Slate	36 kN (8,093 lbf)	95 mm (3.75 in)	125 g (.28 lb)
300701	ProSeries	Red/Slate	38 kN (8,543 lbf)	114 mm (4.5 in)	184 g (.41 lb)



HARDWARE

ProSeries® Aluminum Key-Lock Carabiner

STRONG, DURABLE CARABINER RATED FOR GENERAL USE



NFPA 2500
GENERAL USE



ANSI Z359.12
VERSION AVAILABLE

PATENTED

Combining high performance with minimal weight, the ProSeries Aluminum Key-Lock was the first aluminum carabiner to be certified to NFPA General Use. It offers a significant reduction in weight, while delivering exceptional strength, high safety margin, and efficient ease of use.

Features

- Key-Lock gate system prevents snagging.
- Available in three locking gate options: Screw-Lock, Auto-Lock, and Manual-Lock.
- Fits over a standard litter rail.
- Easy to manipulate and open/close one-handed.
- Manual-Lock is easily locked by pushing down on the gate sleeve.
- 28 mm (1.1 in) gate opening on standard-size carabiner.
- 53 mm (2.1 in) gate opening on XL-size carabiner.
- Removable keeper pin included with XL-size carabiners.
- Proof loaded and individually serial numbered.
- XL ProSeries Keeper Pin Replacement Sets are available: 3 pins, 3 screws, and 1 hex wrench (Item # 300005)



Item #	Gate	Color	3 Sigma MBS	Gate Opening	Interior Length	Weight
300221	Screw-Lock	Brite	44 kN (9,892 lbf)	28 mm (1.1 in)	103 mm (4.05 in)	142 g (.31 lb)
300233	Auto-Lock	Red	40 kN (8,992 lbf)	28 mm (1.1 in)	103 mm (4.05 in)	150 g (.33 lb)
300262	Manual-Lock	Slate	40 kN (8,992 lbf)	28 mm (1.1 in)	103 mm (4.05 in)	150 g (.33 lb)
300241	XL Screw-Lock	Brite	40 kN (8,992 lbf)	53 mm (2.1 in)	168 mm (6.62 in)	266 g (.59 lb)
300253	XL Auto-Lock	Red	40 kN (8,992 lbf)	53 mm (2.1 in)	168 mm (6.62 in)	289 g (.64 lb)
300273*	XL ANSI-Gate	Red	40 kN (8,992 lbf)	53 mm (2.1 in)	168 mm (6.62 in)	322 g (.71 lb)

*Also certified to ANSI (Z359.12)

ProTech™ Aluminum Key-Lock Carabiner

LIGHT, COMPACT CARABINER RATED FOR TECHNICAL USE



NFPA 2500
TECHNICAL USE

PATENTED

The ProTech Aluminum Key-Lock is a lighter weight, lower-profile carabiner with an optimized D-shape to maximize strength and offer a wider gate opening.

Features

- Key-Lock gate system prevents snagging.
- Available in three locking gate options: Screw-Lock, Auto-Lock, and Manual-Lock.
- Fits over a standard litter rail.
- Easy to manipulate and open/close one-handed.
- Manual-Lock is easily locked by pushing down on sleeve.
- Wide gate opening fits over 25 mm (1 in) diameter railings.
- Removable keeper pin available on Auto-Lock model.
- Proof loaded and individually serial numbered.
- ProTech Keeper Pin Replacement Sets are available: 3 pins, 3 screws, and 1 hex wrench (Item # 300000)



Item #	Gate	Color	3 Sigma MBS	Gate Opening	Interior Length	Weight
300161	Screw-Lock	Brite	25 kN (5,620 lbf)	25 mm (1 in)	89 mm (3.5 in)	74 g (.16 lb)
300165	Screw-Lock	Black	25 kN (5,620 lbf)	25 mm (1 in)	89 mm (3.5 in)	74 g (.16 lb)
300169	Screw-Lock	Orange	25 kN (5,620 lbf)	25 mm (1 in)	89 mm (3.5 in)	74 g (.16 lb)
300182	Manual-Lock	Slate	25 kN (5,620 lbf)	25 mm (1 in)	89 mm (3.5 in)	79 g (.17 lb)
300193	Auto-Lock	Red	25 kN (5,620 lbf)	25 mm (1 in)	89 mm (3.5 in)	79 g (.17 lb)
300153	Auto-Lock w/ keeper	Red	28 kN (6,295 lbf)	25 mm (1 in)	89 mm (3.5 in)	102 g (.22 lb)

Aluminum Oval Carabiner



This non-locking carabiner can be used for racking equipment or serve as the keeper carabiner on a load-release strap.

Features

- Key-Lock design for snag-free operation.
- Side-swing gate maximizes gate opening.
- Oval design places equal force on spine and gate, maintaining full strength regardless of width of rope or web.
- Proof loaded and serial numbered.

Item #	Gate	Color	3 Sigma MBS	Gate Opening	Interior Length	Weight
300081	Non-Locking	Brite	22 kN (4,946 lbf)	25 mm (1 in)	89 mm (3.5 in)	65 g (.15 lb)
300083	Non-Locking	Red	22 kN (4,946 lbf)	25 mm (1 in)	89 mm (3.5 in)	65 g (.15 lb)



HARDWARE

Stainless Steel Carabiner



NFPA 2500
GENERAL USE



ANSI Z359.12
VERSION AVAILABLE

Built for harsh conditions. This corrosion-resistant carabiner is made of 100% stainless steel including internal parts such as pins and springs. It has a smooth acting gate and a compact form, making it easy to operate with one hand.

Features

- Body, pins, springs, and all internal parts are 100% stainless steel.
- Key-Lock gate system prevents snagging.
- Side-swing gate maximizes gate opening.
- Non-ANSI version fits over a standard litter rail.
- Three-stage auto-locking gate with visual locking indicator.
- Proof loaded and individually serial numbered.



300010

300011

Item #	Gate	Color	3 Sigma MBS	Gate Opening	Interior Length	Weight
300010	Auto-Lock	Stainless Steel	40 KN (8,992 lbf)	27 mm (1 in)	91 mm (3.6 in)	221 g (.49 lb)
300011*	Auto-Lock	Stainless Steel	40 KN (8,992 lbf)	23 mm (0.9 in)	91 mm (3.6 in)	238 g (.53 lb)

*Also certified to ANSI (Z359.12)

DMM Vault Lock Tool Carrier

The Vault is a secure and durable tool holder that can be used on everything from harnesses and kit bags to vehicles. The two-part aluminum alloy Vault is secured using a stainless steel bolt and is the ideal solution for gear storage, organization, and transportation. Safe, strong, and secure for racking tools or lanyards, the Vault's locking gate can be set to either a locked or unlocked position, and the low profile mechanism does not affect fast clipping. Not PPE.

Features

- One-handed operation for ease of use.
- Top 'shelf' allows in-situ gear selection.
- Low nose profile minimizes snags.
- Can be set to either the unlocked or locked position.
- Max webbing size for attachment: 45 x 3 mm.
- Gate opening: 20 mm.
- User-installed with flat-bladed screwdriver.



Item #	Gate	Color	Working Load Limit	Dimensions	Weight
302552	Manual-Lock	Red/Silver	3 kN (674 lbf)	55 x 110 mm (2.17 x 4.33 in)	79 g (.17 lb)

IMPROVED

ProSteel™ Carabiner



**NFPA 2500
GENERAL USE**



**ANSI Z359.12
VERSION AVAILABLE**

Strong and durable, CMC ProSteel Carabiners are classified to NFPA General Use and have a carbon steel body with a high breaking strength. Where noted, certain models are also certified to ANSI and include a reinforced gate for lateral stress. Designed with a keylock system, wide gate opening, and glove-friendly sleeve, these carabiners are built for tough conditions, yet offer easy handling for everyday applications.

Now available in gray with a new Zinc-Nickel treatment that provides double corrosion resistance from the prior black plating, greater scratch resistance, longer life, more uniform finish, and less friction on textiles.

Features

- Carbon steel carabiner with high tensile strength.
- Wide gate opening for easy loading and unloading.
- Key-Lock gate system minimizes snagging.
- Friction sleeve assists with opening when wearing gloves.
- Burnished finishing for greater visibility of markings.
- Classified to NFPA General Use, select models also ANSI.



Item #	Gate	Color	Major Axis MBS	Dimensions	Weight
300090	Screw-Lock D	Gray/Bronze	48 kN (10,791 lbf)	114 x 76.5 mm (4.5 x 3.0 in)	240 g (0.53 lb)
300092*	Auto-Lock D	Gray/Silver	48 kN (10,791 lbf)	114 x 76.5 mm (4.5 x 3.0 in)	265 g (0.58 lb)
300093	Screw-Lock Oval	Gray/Bronze	40 kN (8,992 lbf)	110 x 62.6 mm (4.3 x 2.5 in)	205 g (0.45 lb)
300094*	Auto-Lock Oval	Gray/Silver	40 kN (8,992 lbf)	110 x 62.6 mm (4.3 x 2.5 in)	220 g (0.49 lb)

*Also certified to ANSI (Z359.12)

IMPROVED

DNA Carabiners



**NFPA 2500 GENERAL USE
VERSION AVAILABLE**



**ANSI Z359.12
VERSION AVAILABLE**

PATENTED

The DNA Carabiners are unique “helical-shaped” connectors with a twisted carbon steel body and circular bar. This twist enables 90° rotation of any connected device for optimal alignment and offset load management.

- Helical shape with 90 degree twist for device alignment and load management.
- Carbon-steel carabiner with high tensile strength.
- Wide gate opening for easy loading and unloading.
- Key-Lock gate system prevents snagging.
- Sleeve is easy to open even wearing gloves.
- Burnished finishing for greater visibility of marking.



Item #	Gate	Color	Classification	Major Axis MBS	Dimensions	Weight
300095	Auto-Lock	Gray/Bronze	ANSI Z359.12	40 kN (8,992 lbf)	108 x 65 mm (4.3 x 2.6 in)	230 g (0.51 lb)
300096	Auto-Lock	Gray/Silver	NFPA General Use	40 kN (8,992 lbf)	108 x 63 mm (4.3 x 2.5 in)	215 g (0.47 lb)



HARDWARE

CMC Ascender



NFPA 2500
GENERAL USE / TECHNICAL USE

Compact and reliable rope grab designed for efficient progression along a life safety rope. Machined from high-strength aluminum alloy with a stepped cam to optimize rope strength and longevity.

Features

- Spring-loaded cam for instant progress capture.
- Stainless steel, quick-release pin allows removal of cam for easy installation at any point on the rope.
- Large connection point accommodates large-size carabiners.
- Machined from aircraft-grade aluminum alloy.
- Useful in situations where a mechanical rope grab provides greater efficiency such as litter tending, travel restrict, and ascending rope.
- Meets the requirements of NFPA General Use for 1/2 inch rope and NFPA Technical Use for 7/16 inch rope (certified using 13 and 11 mm rope).



Item #	Color	Shell	Cam	Rope Size & NFPA Rating	Weight
341103	Red	Aluminum	Spring Loaded	11 mm (7/16 in) - Technical Use 13 mm (1/2 in) - General Use	252 g (.55 lb)

Harken Ninja™ Foot Ascender

Lightweight and durable, the boot-mounted Ninja Foot Ascender uses your body's largest muscle group to ascend a rope quickly and easily.

Features

- Dual-cam system applies pressure to both sides of the rope simultaneously while preventing accidental kick-outs.
- Designed with lower spring force for reduced rope drag.
- Transverse ribbed cam design will not damage rope.
- Lightweight aluminum housing with durable stainless steel cams.



Item #	Dimensions	Rope Diameter	Maximum Rated Load	Weight
342403	83 x 74 mm (3.3 x 2.9 in)	8–13 mm (5/16–1/2 in)	1.5 kN (330 lb)	175 g (0.4 lb)

Climbing Technology Quick Up Ascender

CE EN 567
EN 12841/B

Lightweight aluminum alloy ascender with an ergonomic rubber handle for efficient climbing.

Features

- Rubber handle has support for index finger.
- Cam opening lever can be operated with one hand, and unlocked with one downward movement.
- Cam has three cut-outs to prevent build-up of mud and reduce force needed to slide device up rope.
- Two attachment holes for other devices.



Item #	Color	Grip	Rope Size	Maximum Load	Weight
343035	Gray	Left-Handed	10–13 mm (3/8–1/2 in)	140 kg (309 lb)	215 g (.48 lb)
343039	Orange	Right-Handed	10–13 mm (3/8–1/2 in)	140 kg (309 lb)	215 g (.48 lb)

Climbing Technology Quick Roll Ascender

INNOVATIVE HANDLED ASCENDER WITH AN INTEGRATED PULLEY

CE EN 567
EN 12841/B

The Quick Roll Ascender's integrated pulley can be used in conjunction with a self-braking descender when ascending a rope.

Features

- Integrated pulley facilitates personal ascents by creating a 3:1 when paired with a self-braking descender.
- Allows smooth transitions between ascent and descent using Rapid Ascent/Descent (RAD) Technique.
- Overmolded ergonomic handle for greater efficiency and increased resistance to wear.
- Cam opening lever can be operated with one hand, and unlocked with one downward movement.
- Cam has three cut-outs to prevent build-up of mud and reduce force needed to slide device up rope..
- Patented cam system unlocks with one downward movement.



NOTE: Integrated pulley is only for use as an aid in ascent and is not to be used for hauling people or material.

Item #	Color	Grip	Rope Size	Maximum Load	Weight
343055	Gray	Left-Handed	10–13 mm (3/8–1/2 in)	140 kg (309 lb)	255 g (.56 lb)
343059	Orange	Right-Handed	10–13 mm (3/8–1/2 in)	140 kg (309 lb)	255 g (.56 lb)



HARDWARE

NEW

Harken Ninja™ MultiAscend



CE EN 567
EN 12841/B

The MultiAscend is engineered to provide increased efficiency in a range of applications. The dual cam design enables the MultiAscend to act as both a chest ascender as well as a full point of attachment. The innovative dual-stage locking swingplate ensures consistent engagement with the rope, preventing unwanted detachments. External release triggers make adjusting the MultiAscend safe and easy when used as an ascender or a progress capture device.

When installing the MultiAscend on the ATOM Harness, CMC recommends using our ATOM MultiAscend Strap for optimal integration (sold separately).

Features

- Dual-stage locking swingplate prevents unwanted detachments and allows the device to act as a single point of attachment.
- Twin-cam design reduces rope friction for smooth climbing and less wear and tear on the rope sheath.
- Exterior manual release triggers allow both cams to be fully opened for easy downclimbing without rope snags.
- Supplied shackle links directly to the harness.
- Included strap fits most harnesses - for best integration with the ATOM, CMC recommends using our ATOM MultiAscend Strap.



Item #	Description	Dimensions	Rope Diameter	Maximum Rated Load	Weight
343060	Harken Ninja MultiAscend	76 x 121 mm (3 x 4.25 in)	9–13 mm (5/16–1/2 in)	140 kg (308 lb)	272 g (0.6 lb)
343580	ATOM MultiAscend Strap	38 x 2 cm (15 x .75 in)	N/A	N/A	11 g (.03 lb)

LEARN MORE



ATOM™ Harnesses and the Harken Ninja MultiAscend

The ATOM and MultiAscend combination delivers outstanding comfort and mobility on rope. Order your ATOM Harness with the **Harken Ninja™ MultiAscend** pre-installed using the Build Your Own ATOM tool on our website.



BUILD YOUR OWN ATOM™

Climbing Technology Chest Ascender HC

CE EN 567
EN 12841/B

Features

- Special wear-proof hard coat anodizing, ideal for prolonged use.
- The opening lever's external profile makes climbing the rope smoother and more effective.
- Shape of the opening lever facilitates use when wearing gloves.
- The lower hole design keeps the device parallel to the user.
- Steel cam is durable and has three cut-outs to prevent build-up of mud and reduce force needed to slide device up rope.
- Patented system unlocks cam with one downward movement.
- Anti-inversion cam system.
- Right-handed grip.
- Working load increased to 140 kg.



Item #	Color	Rope Size	Working Load	Weight
343045	Brown	10–13 mm (3/8–1/2 in)	140 kg (309 lb)	147 g (.32 lb)

LEARN MORE



Order your ATOM Harness with the **Climbing Technology Chest Ascender HC** pre-installed using the Build Your Own ATOM tool on our website.



BUILD YOUR OWN ATOM™

Kong Futura Body

CE EN 567
EN 12841/B

Innovative and sleek chest ascender with reduced size and weight at only 80g! Smooth, ergonomic, and easy to operate, this rope clamp is low-profile and highly efficient. Works in combination with other ascent/descent devices like the CLUTCH to offer self-sufficient vertical mobility and hands-free positioning.

Item #	Rope Diameter	Maximum Rated Load	Weight
343021	9–11 mm (5/16–7/16 in)	100 kg (220 lb)	80 g (0.18 lb)



LEARN MORE



Order your Outback™ Convertible Harness with the Chest Ascender Kit featuring the **Kong Futura Body**.



OUTBACK HARNESS



HARDWARE

Kong Backup & Magnet

CE EN 358, EN 353
EN 12841 A/B

ANSI ANSI Z359.12

Compact back-up device with smooth tracking and positioning. Easy to use with one hand, allowing technicians to switch between “Free Mode” for movement and “Lock Mode” to fix the device in place. Reliably arrests falls, slides, or uncontrolled descents on vertical or angled rope. Includes a ProSteel™ auto-locking ANSI carabiner and attachment lanyard.

Placing the Back-Up over a shoulder assists in releasing the cam and allows the device to move freely. This mobility is further enhanced by the Magnet accessory, which holds the Back-Up in place for smooth travel. It's the ideal companion for the rope access technician.

Kong Back-up Device Features

- Sleek, compact back-up device for fall arrest and work positioning.
- Arrests a fall, slide, or uncontrolled descent on vertical or angled rope.
- Smooth tracking, follows operator in both directions of movement.
- Semi-dynamic locking cam mitigates shock and rope damage.
- “Free Mode” enables device movement up and down rope.
- “Lock Mode” fixes the device in place for work positioning.
- Operation can be enhanced with tug cord or magnet accessory.
- Includes ANSI-compliant lanyard and ProSteel™ Carabiner.

Kong Back-up Magnet Features

- Maintains position and orientation of Back-Up Device.
- Allows smooth, hands-free travel up and down rope.
- Included lanyard is certified to EN 354 (not ANSI).
- Lanyard length and location ensures fall factor below 1.



Back-up Device

Magnet

Item #	Description	Rope Diameter	Weight
345672	Kong Back-Up Device	10–12 mm (3/8–1/2 in)	435 g (.94 lb)
345673	Kong Backup Magnet	N/A	100 g (.22 lb)

Anchor Plate



NFPA 2500
GENERAL USE

A classic CMC innovation that has stood the test of time.

Features

- Keeps rigging organized and increases options at the anchor.
- Separates carabiners holding different parts of a system, preventing binding and making hardware easier to check.
- Small holes are 22 mm (.875 in) diameter.
- Large hole is 51 mm (2 in) diameter.



Item #	Model	3 Sigma MBS	Weight
300610	Aluminum, Red	36 kN (8,093 lbf)	204 g (.45 lb)
300615	Stainless Steel	40 kN (8,992 lbf)	278 g (.61 lb)

Micro-Anchor Plate



NFPA 2500
GENERAL USE

When weight and size are critical, choose the compact, lightweight, Micro-Anchor Plate.

Features

- Large hole acts as a collection point for multi-point anchors.
- Small holes keep carabiners organized and separated.
- Oblong shaped holes make inserting carabiners easier.
- Small holes are 16 mm (.63 in) diameter.
- Large hole is 25 mm (1 in) diameter.
- Ultra-compact, light, anodized aluminum anchor plate.



Item #	3 Sigma MBS	Weight
300623	42 kN (9,442 lbf)	74 g (.16 lb)

Spreader Bar



The low-profile design of our Spreader Bar provides more working space with low overhead clearance. The adjustable snap buckles allow an attendant to easily pull up on the straps and shorten the adjustment. Designed for use with CMC's Confined Space Harness. Maximum extension from shoulders to bar is 21 in.

Item #	Width	Weight
202200	38 cm (15 in)	907 g (2 lb)



Rescue 8™



NFPA 2500
GENERAL USE / TECHNICAL USE

Outstanding wear resistance and exceptional control.

Features

- Machined from 12.5 mm (.5 in) aluminum or steel plate.
- Smaller dimensions provide easier handling and greater control with a wide range of rope diameters.
- Extended carabiner hole accommodates multiple carabiners.
- CMC's proprietary, wear resistant finish on Aluminum 8.
- Nickel-chrome plated Steel 8 excels in high-wear situations.
- 3 Sigma MBS for Rescue 8 is 22 kN (4,946 lbf).

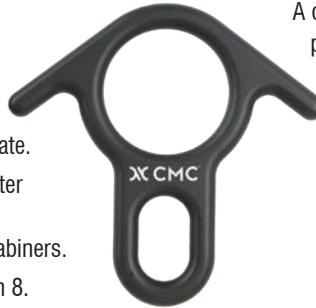

A classic descender refined for improved performance with smaller diameter ropes.



Item #	Material	Color	Rope Size* & Rating	Large Hole	Weight
300840	Aluminum	Black	13 mm (1/2 in) NFPA General Use 9.5–13 mm (3/8–1/2 in) NFPA Technical Use	65 mm (2.5 in) Diameter	187 g (.5 lb)
300850	Steel	Chrome	13 mm (1/2 in) NFPA General Use 9.5–13 mm (3/8–1/2 in) NFPA Technical Use	65 mm (2.5 in) Diameter	539 g (1.2 lb)

*Certified range of rope diameters and CMC's recommendation for best performance.

Rappel 8™



NFPA 2500
TECHNICAL USE

This smaller 8 is preferred by many SWAT teams, climbers, cavers and sport rappellers.

Features

- Machined from 12.5 mm (1/2 in) aluminum plate.
- Offers superb control on 9.5 mm (3/8 in) to 11 mm (7/16 in) diameter ropes.
- Proprietary Super Finish.
- Contains more material than other small 8s for better heat dissipation.



Item #	Material	Color	Rope Size*	Large Hole	NFPA Rating	Weight
300845	Aluminum	Black	9.5-11 mm (3/8–7/16 in)	51 mm (2 in) Diameter	Technical Use	164 g (.36 lb)

*Certified range of rope diameters and CMC's recommendation for best performance.

Survivor 8™



NFPA 2500
ESCAPE

An extremely compact 8 that works well with escape lines and other small diameter ropes.

Features

- Machined from 9.5 mm (.38 in) aluminum plate.
- Rounded edges reduce sharp bends.
- Large carabiner hole helps prevent binding.
- Hard anodized, non-reflective finish.



Item #	Material	Color	Rope Size*	Large Hole	NFPA Rating	Weight
300875	Aluminum	Dark Gray	8.5 mm (5/16 in)	31 mm (1.25 in)	Escape	43 g (.09 lb)

*Certified range of rope diameters and CMC's recommendation for best performance.

Maillon Rapide Quick Links

EN 362, EN 12275



Delta

Oval

These steel quick links, also known as screw links, are popular for use in situations where carabiners are not recommended, such as when there is a risk of tri-axial loading. Strong and versatile connectors that are highly secure when fully closed.

Features

- Ideal for situations where carabiners are not recommended (risk of tri-axial loading).
- Slower to open/close than a carabiner, but more secure when tightened down.
- Delta shape can be used to rig anchors and as a chest harness connector.

Item #	Option	Bar Diameter	Inside Length	Working Load	Breaking Load	Weight
205002	Delta	6 mm	44 mm (1.75 in)	4.4 kN (992 lbf)	22 kN (4,950 lbf)	40 g (.09 lb)
038208	Delta	8 mm	57 mm (2.24 in)	5.4 kN (1,214 lbf)	27 kN (6,070 lbf)	88 g (.19 lb)
382101	Delta	10 mm	67 mm (2.63 in)	8.8 kN (1,984 lbf)	44.1 kN (9,920 lbf)	150 g (.33 lb)
382121	Delta	12 mm	81 mm (3.19 in)	10.8 kN (2,425 lbf)	53.9 kN (12,125 lbf)	258 g (.57 lb)
383051	Oval	5 mm	40 mm (1.56 in)	4.4 kN (992 lbf)	22.1 kN (4,960 lbf)	37 g (.08 lb)
383071	Oval	7 mm	52 mm (2.06 in)	5.4 kN (1,213 lbf)	27 kN (6,065 lbf)	51 g (.11 lb)
383121	Oval	12 mm	81 mm (3.19 in)	14.7 kN (3,307 lbf)	73.6 kN (16,535 lbf)	233 g (.51 lb)
384101	Long Oval	10 mm	86 mm (3.38 in)	9.8 kN (2,205 lbf)	49 kN (11,025 lbf)	159 g (.35 lb)

Kong Trapezium Quick Link

This stainless steel quick link is ideal for connecting the CMC Bullnose Lanyard or other lanyards to a harness without taking up space on the ventral D-Ring. It can also be used to integrate a chest ascender into a full body harness.

Features

- Semi-permanent connection when closed with a wrench.
- Elongated shape allows wider gate opening.
- Creates lanyard attachment point below harness D-Ring.

Dimensions: 82 x 68 mm (3.23 x 2.68 in)



Item #	Diameter	MBS	Weight
385640	9 mm (5/16 in)	33 kN (7,418 lbf)	129 g (.28 lb)

Aluminum O-Ring



A small, strong connection point machined from high-strength aluminum bar stock. Rounded inner surface minimizes rope bend and allows smooth movement.



Item #	Diameter	MBS	Weight
302900	33 mm (1.31 in)	22.2 kN (5,000 lbf)	31 g (.07 lb)

Steel O-Ring

A drop-forged, alloy steel connection point made from 12.7 mm (.5 in) stock. Allows the attachment of control lines, a litter harness, and pulleys—all at one strong point.



Item #	Diameter	MBS	Weight
305011	76 mm (3 in)	44.5 kN (10,000 lbf)	309 g (.68 lb)



HARDWARE





ROPE & WEB





NEW

CMC G11™

HIGH STRENGTH AND DURABILITY, LOW WEIGHT AND VOLUME



NFPA 2500
GENERAL USE



POLYESTER SHEATH



NYLON CORE

CMC's new and improved G11 represents the next generation of our leading 11 mm NFPA General Use rope. Our new CMC G11 provides greater durability than its predecessor while delivering the same high strength and compact size. Constructed with a nylon core and 48 carrier polyester sheath, CMC G11 is optimized for safety, performance, and knotability. It provides a firm, cohesive feel while remaining supple, lightweight, and easy to handle. CMC G11 is the ideal rope for 11 mm G-Rated systems such as the Double CLUTCH TTRS.

Features

- 11 mm NFPA General Use rope that is light, compact, and high strength.
- Kernmantle construction with a polyester sheath and nylon core.
- New 48 carrier count braided sheath for greater durability.
- Available in 4 colors and 3 lengths, as well as custom lengths up to 1,300 ft.
- Melting point is 215° C (419° F).

Advantages of building 11 mm systems with CMC G11:

CMC G11's fiber-core technology reduces weight and volume, but not strength. This innovation means rescuers can use more compact hardware, reducing weight and volume throughout their cache. When the CLUTCH and CMC G11 are combined, the result is a versatile G-Rated system with greater safety and efficiency for every haul, lower, ascent, and descent. Additionally, CMC G11 promotes wider collaboration between rope professionals across industries and continents. Standardizing to 11 mm allows teams everywhere to learn and train on the same systems and equipment. Techniques can be more easily shared, adapted, and improved for the benefit of the community.



G11 Sold By the Hank

Item #	NFPA Rating	Color/Tracer	Diameter	Elongation Percent			3 Sigma MBS	Length
				1.35 kN (300 lbf)	2.7 kN (600 lbf)	4.4 kN (1,000 lbf)		
283131-150	General Use	Orange/White	11 mm (7/16 in)	3.1	5.1	7.6	40.5kN (9,107 lbf)	45.7 m (150 ft)
283131-200	General Use	Orange/White	11 mm (7/16 in)	3.1	5.1	7.6	40.5kN (9,107 lbf)	60.9 m (200 ft)
283131-300	General Use	Orange/White	11 mm (7/16 in)	3.1	5.1	7.6	40.5kN (9,107 lbf)	91.4 m (300 ft)
283132-150	General Use	Blue/White	11 mm (7/16 in)	3.1	5.1	7.6	40.5kN (9,107 lbf)	45.7 m (150 ft)
283132-200	General Use	Blue/White	11 mm (7/16 in)	3.1	5.1	7.6	40.5kN (9,107 lbf)	60.9 m (200 ft)
283132-300	General Use	Blue/White	11 mm (7/16 in)	3.1	5.1	7.6	40.5kN (9,107 lbf)	91.4 m (300 ft)
283133-150	General Use	Red/White	11 mm (7/16 in)	3.1	5.1	7.6	40.5kN (9,107 lbf)	45.7 m (150 ft)
283133-200	General Use	Red/White	11 mm (7/16 in)	3.1	5.1	7.6	40.5kN (9,107 lbf)	60.9 m (200 ft)
283133-300	General Use	Red/White	11 mm (7/16 in)	3.1	5.1	7.6	40.5kN (9,107 lbf)	91.4 m (300 ft)
283137-150	General Use	Yellow/White	11 mm (7/16 in)	3.1	5.1	7.6	40.5kN (9,107 lbf)	45.7 m (150 ft)
283137-200	General Use	Yellow/White	11 mm (7/16 in)	3.1	5.1	7.6	40.5kN (9,107 lbf)	60.9 m (200 ft)
283137-300	General Use	Yellow/White	11 mm (7/16 in)	3.1	5.1	7.6	40.5kN (9,107 lbf)	91.4 m (300 ft)

G11 Sold By the Foot

Item #	NFPA Rating	Color/Tracer	Diameter	Elongation Percent			3 Sigma MBS	Weight per 100 ft
				1.35 kN (300 lbf)	2.7 kN (600 lbf)	4.4 kN (1,000 lbf)		
283131	General Use	Orange/White	11 mm (7/16 in)	3.1	5.1	7.6	40.5kN (9,107 lbf)	2.83 kg (6.25 lb)
283132	General Use	Blue/White	11 mm (7/16 in)	3.1	5.1	7.6	40.5kN (9,107 lbf)	2.83 kg (6.25 lb)
283133	General Use	Red/White	11 mm (7/16 in)	3.1	5.1	7.6	40.5kN (9,107 lbf)	2.83 kg (6.25 lb)
283137	General Use	Yellow/White	11 mm (7/16 in)	3.1	5.1	7.6	40.5kN (9,107 lbf)	2.83 kg (6.25 lb)

Practice Your Knots



Learn Your Knots Video Series

Watching CMC's Learn Your Knots video series allows you to practice the most commonly used knots for rescue and rope access. Build your fundamentals and prepare for your next CMC School Class!



**SCAN TO
WATCH VIDEOS!**

Static-Pro™

SMOOTH HANDLING, LOW-STRETCH POLYESTER ROPE



NFPA 2500



POLYESTER SHEATH



POLYESTER CORE

Features

- Kernmantle construction with a polyester sheath and polyester core.
- Recommended for high lines, long rappels, and mechanical advantage haul systems.
- Excellent hand, knotability, and UV resistance.
- High Tenacity Polyester (HTP) fiber protects against abrasion and doesn't absorb water, maintaining strength when wet.
- Solid color sheath with a single stripe.
- Block creel, static kernmantle construction.
- 32 carrier braided sheath with half the strands in a left (Z) twist and half in a right (S) twist for a balanced, torque-free rope with maximum abrasion resistance.
- Melting point is 249° C (480° F).



Item #	NFPA Rating	Color/Tracer	Diameter	Elongation Percent at			3 Sigma MBS	Weight/100 ft
				1.35 kN (300 lbf)	2.7 kN (600 lbf)	4.4 kN (1,000 lbf)		
281102	Technical Use	Blue/White	11 mm (7/16 in)	0.9	1.4	2.5	35.2 kN (7,915 lbf)	2.9 kg (6.5lb)
281103	Technical Use	Orange/White	11 mm (7/16 in)	0.9	1.4	2.5	35.2 kN (7,915 lbf)	2.9 kg (6.5lb)
281109	Technical Use	Red/White	11 mm (7/16 in)	0.9	1.4	2.5	35.2 kN (7,915 lbf)	2.9 kg (6.5lb)
281200	General Use	White/Blue	12.5 mm (1/2 in)	0.9	1.5	2.1	40.8 kN (9,164 lbf)	3.9 KG (8.5 lb)
281201	General Use	Orange/White	12.5 mm (1/2 in)	0.9	1.5	2.1	40.8 kN (9,164 lbf)	3.9 KG (8.5 lb)
281202	General Use	Blue/White	12.5 mm (1/2 in)	0.9	1.5	2.1	40.8 kN (9,164 lbf)	3.9 KG (8.5 lb)
281203	General Use	Red/White	12.5 mm (1/2 in)	0.9	1.5	2.1	40.8 kN (9,164 lbf)	3.9 KG (8.5 lb)
281207	General Use	Yellow/White	12.5 mm (1/2 in)	0.9	1.5	2.1	40.8 kN (9,164 lbf)	3.9 KG (8.5 lb)

Static-Pro is sold by the foot. Rope ends are included. No charge on custom cutting. Please contact CMC customer support for maximum length available.

CMC Lifeline™

HIGH-PERFORMING 100% NYLON ROPE



NFPA 2500



NYLON SHEATH



NYLON CORE

Features

- Kernmantle construction with a nylon sheath and nylon core.
- Recommended for a wide range of rescue and rope access applications.
- Optimum balance of strength, handling, knotability, durability, and minimal sheath slippage.
- Provides a high level of control when used with a descent control device.
- Solid color sheath.
- Block creel, static kernmantle construction.
- 32 carrier braided sheath with half the strands in a left (Z) twist and half in a right (S) twist for a balanced, torque-free rope with maximum abrasion resistance.
- Melting point is 238° C (460° F).

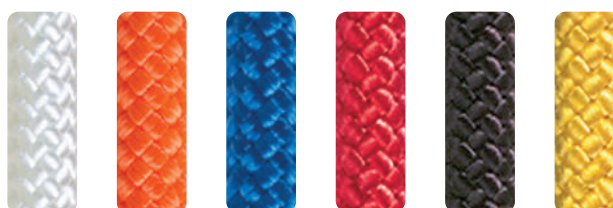

Item #	NFPA Rating	Color	Diameter	Elongation Percent at			3 Sigma MBS	Weight/100 ft
				1.35 kN (300 lbf)	2.7 kN (600 lbf)	4.4 kN (1,000 lbf)		
272810	Technical Use	Orange	11 mm (7/16 in)	2.7	5.6	8.7	28.6 kN (6,421 lbf)	2.5 kg (5.5 lb)
272830	Technical Use	Red	11 mm (7/16 in)	2.7	5.6	8.7	28.6 kN (6,421 lbf)	2.5 kg (5.5 lb)
272850	Technical Use	Black	11 mm (7/16 in)	2.7	5.6	8.7	28.6 kN (6,421 lbf)	2.5 kg (5.5 lb)
263200	General Use	White	13 mm (1/2 in)	2.0	4.0	6.6	41.3 kN (9,285 lbf)	3.5 kg (7.7 lb)
273210	General Use	Orange	13 mm (1/2 in)	2.0	4.0	6.6	41.3 kN (9,285 lbf)	3.5 kg (7.7 lb)
273220	General Use	Blue	13 mm (1/2 in)	2.0	4.0	6.6	41.3 kN (9,285 lbf)	3.5 kg (7.7 lb)
273230	General Use	Red	13 mm (1/2 in)	2.0	4.0	6.6	41.3 kN (9,285 lbf)	3.5 kg (7.7 lb)
273250	General Use	Black	13 mm (1/2 in)	2.0	4.0	6.6	41.3 kN (9,285 lbf)	3.5 kg (7.7 lb)
273270	General Use	Yellow	13 mm (1/2 in)	2.0	4.0	6.6	41.3 kN (9,285 lbf)	3.5 kg (7.7 lb)
274010	General Use	Orange	15.5 mm (5/8 in)	1.2	2.6	4.8	49.9 kN (11,227 lbf)	5 kg (11 lb)

CMC Lifeline is sold by the foot. Rope ends are included. No charge on custom cutting. Please contact CMC customer support for maximum length available.



ROPE & WEB

Teufelberger KM III

VERSATILE AND DURABLE KERNMANTLE ROPE



NFPA 2500



EN 1891: TYPE A



POLYESTER SHEATH



NYLON CORE

Features

- Kernmantle construction with a polyester sheath and nylon core.
- Weight-balanced construction, with the sheath and core each making up half the rope's weight.
- Excellent handling and knotability, and torque balanced to eliminate spin during rappels.
- Polyester sheath protects against abrasion and harsh chemicals, and will not absorb water.
- Solid color sheath with two stripes (black sheath has no stripes).
- Block creel, static kernmantle construction.
- 32 carrier braided with half the strands in a left (Z) twist and half in a right (S) twist for a balanced, torque-free rope with maximum abrasion resistance.
- Nylon Core with High Tenacity Polyester Sheath.
- Melting point is 238° C (460° F).



Item #	NFPA Rating	Color	Diameter	Elongation Percent at			3 Sigma MBS	Weight/100 ft
				1.35 kN (300 lbf)	2.7 kN (600 lbf)	4.4 kN (1000 lbf)		
K00120	Technical Use	White/Blue	9.5 mm (3/8 in)	2.0	5.0	8.0	27.4 kN (6,160 lbf)	2.1 kg (4.6 lb)
K05120	Technical Use	Orange/Blue	9.5 mm (3/8 in)	2.0	5.0	8.0	27.4 kN (6,160 lbf)	2.1 kg (4.6 lb)
K00140	Technical Use	White/Blue	11 mm (7/16 in)	2.2	4.4	6.8	33.3 kN (7,486 lbf)	2.8 kg (6.1 lb)
K05140	Technical Use	Orange/Blue	11 mm (7/16 in)	2.2	4.4	6.8	33.3 kN (7,486 lbf)	2.8 kg (6.1 lb)
K00160	General Use	White/Blue	13 mm (1/2 in)	1.4	2.7	4.5	43.3 kN (9,734 lbf)	3.6 kg (7.9 lb)
K01160	General Use	Red/White	13 mm (1/2 in)	1.4	2.7	4.5	43.3 kN (9,734 lbf)	3.6 kg (7.9 lb)
K02160	General Use	Safety Green/Blue	13 mm (1/2 in)	1.4	2.7	4.5	43.3 kN (9,734 lbf)	3.6 kg (7.9 lb)
K03160	General Use	Blue/White	13 mm (1/2 in)	1.4	2.7	4.5	43.3 kN (9,734 lbf)	3.6 kg (7.9 lb)
K04160	General Use	Black	13 mm (1/2 in)	1.4	2.7	4.5	43.3 kN (9,734 lbf)	3.6 kg (7.9 lb)
K05160	General Use	Orange/Blue	13 mm (1/2 in)	1.4	2.7	4.5	43.3 kN (9,734 lbf)	3.6 kg (7.9 lb)

KM III is sold by the foot. Rope ends are included. No charge on custom cutting. Please contact CMC customer support for maximum length available.

Prusik & Load Release Hitch Cord



Meets the key requirements for cord used in Prusik hitches - reliable handling, diameter, and strength.

Features

- Provides the right balance of suppleness for reliable activation and sheath durability for long lasting use.
- 100% nylon with torque-free, kernmantle construction.
- Solid color sheath helps distinguish from ordinary accessory cords.
- Available in diameters ranging from 6 mm to 9 mm. Two color choices for 6 mm, 7 mm, and 8 mm diameter cords.
- 9 mm cord is preferred for use in a load-releasing hitch.

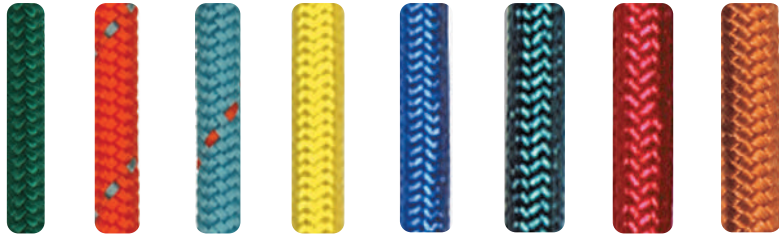

Item #	Diameter	Color	MBS	Weight/ft
293011	6 mm	Orange/Blue	8 kN (1,798 lbf)	8.5 g (.02 lb)
293012	6 mm	Blue/Orange	8 kN (1,798 lbf)	8.5 g (.02 lb)
293017	7 mm	Yellow	8 kN (1,798 lbf)	8.5 g (.02 lb)
293037	7 mm	Blue	8 kN (1,798 lbf)	8.5 g (.02 lb)
293018	8 mm	Green	14 kN (3,147 lbf)	14 g (.03 lb)
293038	8 mm	Red	14 kN (3,147 lbf)	14 g (.03 lb)
293039	9 mm	Orange	15 kN (3,372 lbf)	17 g (.04 lb)

Sewn-Loop Prusiks



The product of years of testing and development, CMC's Sewn-Loop Prusiks offer unmatched performance.

Features

- Strength equivalent to a tied Prusik—without the knot.
- Factory-sewn SecureStitch™ is covered with durable clear shrink tubing that allows inspection and protects stitching.
- Made with CMC's proprietary 8 mm Prusik cord.
- Comes with shrink tubing to protect stitching (do not remove)

Diameter: 8 mm | **MBS:** 20 kN (4,496 lbf)

Item #	Size	Color	Length	Weight
293083	Short	Red	46 cm (18 in)	48 g (.11 lb)
293086	Long	Green	63.5 cm (25 in)	62 g (.14 lb)

AZ Bound-Loop Prusiks



Identical to Sewn-Loop Prusiks except that shrink tubing captures both sides of the loop, allowing it to be adjusted.

Features

- Designed for technicians who prefer a bound-loop Prusik for cinching the attachment bight around a carabiner in order to snug the Prusik to the connector.
- Factory-sewn SecureStitch™ is covered with durable clear shrink tubing that allows inspection and protects stitching.
- Made with CMC's proprietary 8 mm Prusik cord.
- Comes with shrink tubing to protect stitching (do not remove)

Diameter: 8 mm | **MBS:** 20 kN (4,496 lbf)

Item #	Size	Color	Length	Weight
293383	Short	Red	46 cm (18 in)	48 g (.11 lb)
293386	Long	Green	63.5 cm (25 in)	62 g (.14 lb)



NFPA Throwline



NFPA 2500 THROWLINE

Meets all NFPA specifications for a floating water rescue line.



Features

- Dyneema® core and polypropylene sheath.
- Excellent handling.
- Bright yellow for high visibility.

Item #	Diameter	3 Sigma MBS	Weight/100 ft
293387	7.5 mm (19/64 in)	15 kN (3,372 lbf)	907 g (2 lb)

SRT Throwline



Provides the versatility of a throwline with the larger diameter needed for a better grip.



Features

- A high visibility rope that floats.
- Abrasion resistant nylon sheath and polypropylene core.
- Supple enough to fit into a compact throw bag.
- Has added strength and ease of grip needed to set tension diagonals or boat lines.

Item #	Diameter	MBS	Weight/100 ft
292957	9.5 mm (3/8 in)	13 kN (2,922 lbf)	1.8 kg (3.9 lb)

Redi-Line™ Throwline



An excellent, cost-effective choice for shore-based responders.



Features

- Polypropylene line with hollow-braid construction.
- Easy to handle and stuff into a throw bag.
- Red/white stripe rope has high visibility in and out of water.

Item #	Diameter	MBS	Weight/100 ft
292763	11 mm (7/16 in)	10 kN (2,248 lbf)	1 kg (2.3 lb)

SEE MORE

Throwline Bag Sets. See Page 153.

River Rescue Rope



Intended for high-load applications that normally call for a lifeline, but also require a rope that floats.



Features

- Compatible with Prusiks, ascenders, pulleys, and other rescue hardware.
- Abrasion-resistant nylon sheath with polyolefin core.

Item #	Diameter	MBS	Weight/100 ft
293220	11 mm (7/16 in)	16.45 kN (3,700 lbf)	2.3 kg (5 lb)

Escape Line



NFPA 2500 ESCAPE

A low-stretch kernmantle escape line that provides outstanding performance.



Features

- Low-stretch, 8.2 mm diameter kernmantle construction.
- Polyester sheath with nylon core.
- Large enough diameter for easy handling, but compact when stuffed in bag or pocket.
- Melting point 238° C (460° F).
- Orange sheath with yellow stripe.

Item #	3 Sigma MBS	Weight/100 ft
K05100	21 kN (4,721 lbf)	1.6 kg (3.5 lb)

ProSeries® Escape Line



NFPA 2500 FIRE ESCAPE

Made of 100% Technora® fiber for high strength, abrasion resistance, and durability when exposed to heat and flame.



Features

- Core and sheath are made of Technora fiber.
- 7.5 mm diameter static kernmantle construction.
- Extensively tested under static and dynamic conditions.
- Char point 482° C (900° F).
- Tan sheath with black stripe.

Item #	3 Sigma MBS	Weight/100 ft
292015	29 KN (6,519 lbf)	1.5 kg (3.4 lb)



Reflective RIT Line



High-visibility Technora® and polyester line for Rapid Intervention Teams made even more visible by a strand of highly reflective 3M™ tape.



Features

- Technora strands for high strength in adverse conditions.
- Supple enough to pack easily, but firm enough to be felt against a floor in low-visibility conditions when wearing gloves.
- Technora chars at 482° C (900° F), polyester melts at 249° C (480° F).
- Tan and orange sheath with yellow and reflective stripes.

Item #	Diameter	MBS	Weight/100 ft
292005	5.8 mm	7 kN (1,574 lbf)	712 g (1.6 lb)

Ladder Line



Spun polyester sheath provides a secure grip with or without gloves, whether wet or dry.



Features

- Resistance to UV, rot, and mildew extends service life.
- Splice or use a halyard clamp for easy installation.
- NFPA 1931 specifies an MBS of 3.67 kN (825 lbf) for halyards.
- White sheath with red tracer.

Item #	Diameter	MBS	Weight/100 ft
293120	9.5 mm (.38 in)	13.8 kN (3,102 lbf)	2.2 kg (4.8 lb)
293160	12.5 mm (.5 in)	25.6 kN (5,755 lbf)	3.6 kg (8 lb)

Halyard Clamp

Quick and easy installation, requiring only a mallet to fold the prongs over on a doubled rope.



Features

- Clamp slips at 3.6 kN (800 lbf).
- Fits both 9.5 mm (3/8 in) and 12.5 mm (1/2 in) ladderline.

Item #	Weight
294200	54 g (.12 lb)

Tubular Web



After extensive research of web construction, manufacturers' tests, and field evaluations, CMC determined that this mil-spec, needle loom web provides excellent strength, durability, and suppleness for knot tying. Its performance is comparable to previous generation shuttle loom (spiral weave) web.

One-inch web is sold by the foot, with a maximum spool length of 92 m (300 ft). Note: Military standards allow for up to three sections per spool.



Item #	Width	Color	MBS	Spool Length	Weight/ft
200101	25 mm (1 in)	Orange	17.8 kN (4,000 lbf)	91 m (300 ft)	14 g (.03 lb)
200102	25 mm (1 in)	Blue	17.8 kN (4,000 lbf)	91 m (300 ft)	14 g (.03 lb)
200103	25 mm (1 in)	Red	17.8 kN (4,000 lbf)	91 m (300 ft)	14 g (.03 lb)
200105	25 mm (1 in)	Black	17.8 kN (4,000 lbf)	91 m (300 ft)	14 g (.03 lb)
200106	25 mm (1 in)	Green	17.8 kN (4,000 lbf)	91 m (300 ft)	14 g (.03 lb)
200107	25 mm (1 in)	Yellow	17.8 kN (4,000 lbf)	91 m (300 ft)	14 g (.03 lb)
200110	25 mm (1 in)	Brown	17.8 kN (4,000 lbf)	91 m (300 ft)	14 g (.03 lb)

Flat Web



Proven to be an excellent performer across a range of applications and used for many years in CMC School Classes.

Features

- Supple enough to set knots securely.
- Easier to untie than tubular web after heavy loads.
- Bulkier than tubular web, but significantly higher in strength.
- Nylon construction.

Width: 25 mm (1 in)
MBS: 26.7 kN (6,000 lbf)
Roll Length: 46 m (150 ft)
Weight/ft: 20 g (.04 lb)

Item #	Color
200111	Orange
200117	Yellow

Available by the foot or roll. Note: Industry standards allow for up to three sections per roll.



Fire Escape Web



NFPA 2500 - FIRE ESCAPE

Developed at the request of firefighters who wanted a more compact, lightweight escape solution.

Features

- 100% Technora® fiber for superior strength and durability when exposed to flame.
- Designed for use in CMC escape descenders.



Item #	Width	Color	3 Sigma MBS	Weight/100 ft
200517	11 mm	Tan	27 kN (6,070 lbf)	1.1 kg (2.5 lb)

SEE MORE

CMC LEVR Escape Systems
 Designed for rapid emergency egress. See Page 88.



Ultra-Pro™ Edge Protectors



Sought-after, highly effective, and featured edge protector.

Features

- Super-slick, high-performance material greatly reduces friction while protecting rope from sharp or rough edges.
- Lighter and easier to transport than edge rollers.
- Conforms to the edge while preventing sharp bends.
- Avoids the tipping hazard associated with taller devices.
- Holes in all four corners allow device to be tied off or linked together for extended protection.
- Ultra-Pro 2 accepts two ropes.
- Ultra-Pro 4 accepts four ropes.

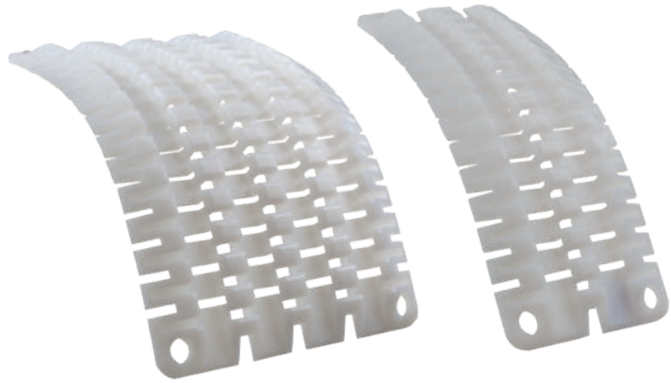

Item #	Option	Length x Width
294042	Ultra Pro 2	41 x 15 cm (16 x 6 in)
294044	Ultra Pro 4	41 x 25 cm (16 x 10 in)

Edge Pad

Provides heavy-duty protection from abrasion and helps keep ropes clean, extending their life.

Features

- Made from rugged 24 ounce, #4 canvas.
- Also provides protection when wrapped around trees, rails, or beams.
- Reduces the amount that ropes dig into soft edges, such as berms of a road.
- Superior design replaces metal grommets with integrated corner web loops that allow anchoring.
- Additional web loops on the side of pad allow two or more pads to be joined for extended coverage.



Item #	Size	Length x Width	Weight
294018	Large	71 x 86 cm (28 x 34 in)	.07 kg (1.4 lb)
294019	X-Large	147 x 86 cm (58 x 34 in)	1.2 kg (2.6 lb)
294025	XX-Large	292 x 86 cm (115 x 34 in)	2 kg (4.4 lb)

Edge Guard



Tough protection for anchor ropes, rescue ropes, and webbing.

Features

- Made from tough #4 duck canvas with an outside layer of vinyl-coated polyester.
- Closes with a 2-in wide strip of hook-and-loop fastener.
- An integrated strong web loop at each end allows anchoring to be held in place.

Item #	Length	Weight
294030	46 cm (18 in)	184 g (.41 lb)
294029	61 cm (24 in)	241 g (.53 lb)

Born Entry-Ease



Transforms the edge of a manhole into a smooth surface that a person or stretcher can easily slide over.



Features

- Stainless steel construction.
- Fits entries as small as 46 cm (18 inches) in diameter.
- Also works on railings, pipes, ladder rungs, and other surfaces that may damage a lifeline.
- May be the only workable option in locations with low overhead clearance.

Item #	Color	Weight
735100	Stainless Steel	2 kg (4.4 lb)

SEE MORE AT CMCPRO.COM

CMC Rope Ends

Creates a clean, finished end on rope or cord. Black color with CMC logo.

6-11 mm rope **Item #294550**

11-16 mm rope **Item #294575**

Shrink Tubing

Protects labels on ropes. Sold by the foot.

6-11 mm rope **Item #294312**

11-16 mm rope **Item #294358**

Rope Bag Card Set

Fits into the clear-view display sleeve on CMC Rope and Rope and Equipment Bags. Provides quick reference to important details.

Item #994000

Rope Log

All-weather log for documenting rope details and information. **Item #993213**







ANCHORS & STRAPS



Arizona Vortex Kit

OUTSTANDING ARTIFICIAL HIGH DIRECTIONAL



NFPA 2500
GENERAL USE

The Arizona Vortex Kit delivers a versatile tripod, bipod, and monopod in one all-inclusive package. Refined through years of development in the rugged highlands of northern Arizona, the Vortex Kit offers a combination of adaptability, ease of use, and rapid deployment that no other multi-pod can match.

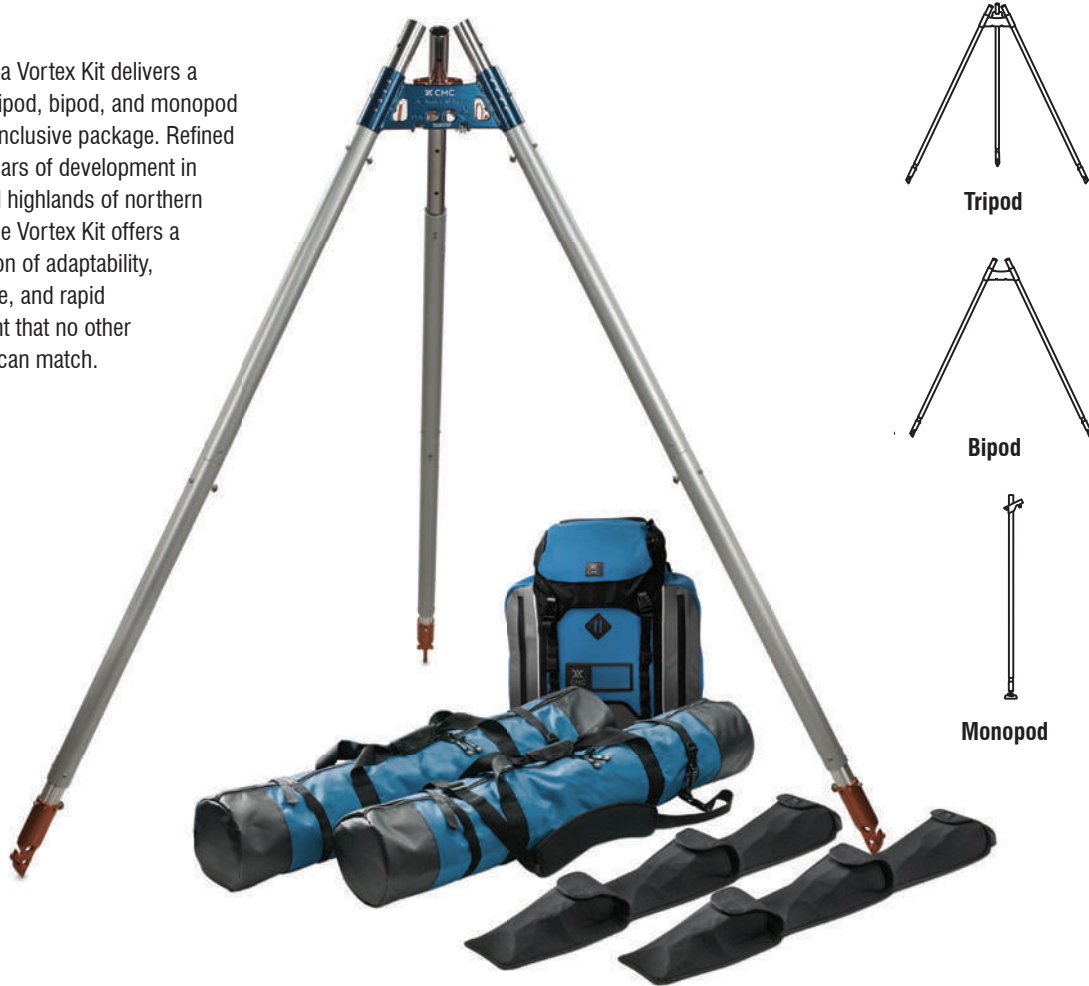

Features

- The Vortex provides an artificial high directional in virtually any urban, industrial, or wilderness application.
- Vortex bag set is configured with a RigTech Pack™ and 2 redesigned Leg Bags, allowing for single person transport.
- The precision-machined two-piece head can be rigged as a standard tripod, an A-frame, a gin pole, and many other configurations.
- Easily adjustable leg lengths and an articulating third leg allow the Vortex head to be positioned closer to an edge than a conventional tripod.
- Pulleys can be connected directly to the head, eliminating loss of clearance when working with high lines and tracking line offsets.
- Multiple attachment points on the head are useful for rope access applications where several lines may be needed over the edge.
- Both Raptor (pointed) and Flat (gimbaled ball and socket) foot sets are included to allow secure setup on any terrain and application. Flat Feet now come with an improved rubber pad that can be easily replaced when needed.
- Vortex Accessories increase overall versatility including the Arizona Omni Rigging Pod (AZORP) for additional rigging options and the Sedona Shoulder Harness for backpack-style carry of the Vortex Leg Bags.

Versatility is Key

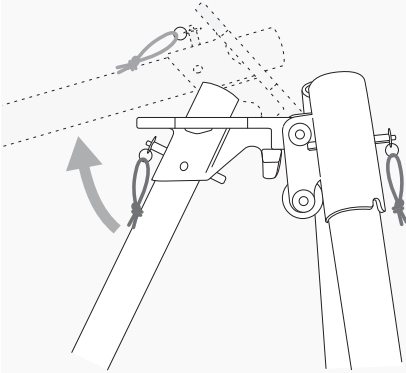

The Arizona Vortex's hinged, articulating head allows the third leg to move independently of the other two, vastly increasing its versatility as a high directional / portable anchor.

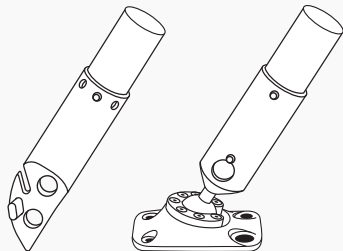

Two foot sets (3 in each set) are provided in the Arizona Vortex Kit. Pointed "Raptor" feet allow setup in rough or rocky terrain. Gimballed ball and socket "Flat" feet are intended for use in urban or industrial environments.

Arizona Vortex Kit Includes

- 2-piece Head Set
- Head Set Pulley Wheel
- Quick Pins for Head (4)
- Inner Legs (3)
- Outer Legs (7)
- Quick Pins for Legs/Feet (17)
- Flat (Omni) Feet (3)
- Raptor (Claw) Feet (3)
- Orange Quick Pin Flags (21)
- Adjustable Hobble Straps (3)
- 12 m (40ft) 8 mm Tether Cord
- User Manual
- Vortex Bag System:
 - RigTech Pack (1)
 - Leg Bags with Shoulder Straps (2)
 - Sleeves for Foot Sets (2)
 - Storage bag for Quick Pins

Item #	Color	NFPA Rating	3 Sigma MBS	Weight
727300	Blue/Orange/Brite	General Use	36 kN (8,093 lbf)	43 kg (95 lb)

Arizona Vortex Accessories

Item #	Description
727400	Arizona Omni Rigging Pod (AZORP) Kit
727501	Arizona Omni Rigging Pod (AZORP) Replacement Pin
727240	Replacement Pin Set (2 Head Pins, 4 Leg Pins)
727030	Inner Leg (Brite)
727040	Outer Leg (Gray)
727090	Head Set Pulley Wheel
727140	Arizona Vortex Hobble Strap
727195	Sedona Shoulder Harness (Black/Gray)



The Arizona Omni Rigging Pod (AZORP) is an optional accessory that increases versatility by providing two component halves that can be used in combination, or separately, at different positions on the inner or outer Vortex legs. Comes with two (2) pins and storage bag.



CMC Triskelion™

A NEW BENCHMARK IN EASE OF USE AND RAPID DEPLOYMENT



NFPA 2500
GENERAL USE



EN 795
CEN/TS 16415

The CMC Triskelion is a fully featured industrial rescue tripod that sets a new benchmark for rapid deployment, ease of use, and versatility. With its 5.5 – 10 ft working height, certification to NFPA and EN standards, and multiple rigging options, the Triskelion delivers greater safety and efficiency for confined space and industrial rescues.



Rapid Deployment



10 ft Max Height



NFPA General Use

Features

- Third-party certification to NFPA General Use, EN 795, and CEN/TS 16415 assures the Triskelion meets the strength requirements for each standard and the demands of global use.
- 10 ft max working height allows rescuers to haul patients from a confined space using a harness or litter and 5.5 ft min working height facilitates access in low-clearance areas. 4 in leg increments help fine tune tripod height.
- Rectangular legs with built-in stoppers, tethered push pins, and high contrast graphics allow teams to quickly and easily align adjustment holes and set the desired height.
- Includes leg packing strap and reinforced carry bag with diagram for proper packing, easily carried by two people using end handles or a single person using the padded center shoulder strap.
- Supported by custom accessories that enhance its capabilities and make it even easier to use including Winch Adapters, Foot Steps, and Ground Stakes.
- A single red webbing hobble strap secures all three legs at the base with a quick-connect Cobra Buckle, creating a system that is easier to see and lighter weight than chain, and faster than using multiple lengths of material.

Adaptable Feet

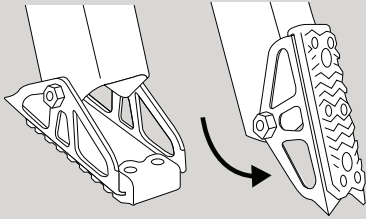

The pivoting feet have non-slip tread for hard floors and spiked tips for soft earth. A highly visible red hobble strap with a quick-connect Cobra Buckle is included to secure the feet at the base.

Rigging Options

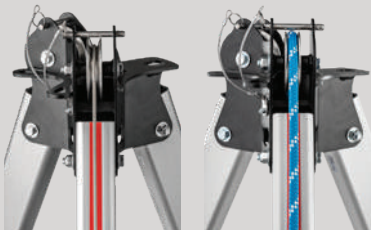

Rigging options include two head-mounted stainless steel pulleys compatible with cable and rope up to 13 mm (1/2 in), three side-plate anchor points ideal for hauling systems, several mounting options for the Harken LokHead Winch and DBI-Sala Salalift II Winch, and an Equipment Bracket accessory for attaching rope hardware.

SEE MORE

Harken LokHead Winch Kit.
See Page 74.

Triskelion Includes

- Triskelion Tripod
- Hobble Strap
- Carry Bag
- Leg Strap
- User Manual

Triskelion Specifications

- Diameter inside of feet 1580 - 2820 mm (62.2 - 111 in)
- Diameter outside of feet 1930 - 3170 mm (76 - 125 in)
- MBS attached direct to head 36 kN (8,093 lbf)
- MBS attached to leg over pulley 22 kN (4946 lbf)

Item #	Color	Tripod Weight	Dimension L x W x H (mm)
760001	Silver/Red	32 kg (70 lb)	1700 x 310 x 310

Triskelion Accessories

Item #	Description
760012	Triskelion LokHead Winch Adapter
760014	Triskelion Salalift II Winch Adapter
760015	Triskelion Foot Step Kit
760016	Triskelion Ground Stake Kit
760017	Triskelion Equipment Bracket



LokHead Winch Adapter



Foot Step Kit (2 Steps)



DBI/SALA Salalift II Winch Adapter



Ground Stake Kit (3 Stakes)



Equipment Bracket



Harken LokHead Winch Kit



A proven high-load, low-friction winch designed for rescue operations. The LokHead can be used anywhere a load needs to be lifted or lowered. Rigged to a tripod, it can be used for confined-space rescue, for load moving/hauling, and personnel hoisting.



Item #	Max Rated Load (Goods and Equipment)	Max Rated Load (Rescue Loads)	Weight
733500	500 kg (1,102 lb)	220 kg (485 lb)	14.5 kg (32 lb)

Features

- Lightweight, easy to rig, and efficient with a 40:1 power ratio and 2 speeds.
- Can be driven manually with the provided handle or by using a power drill combined with the Harken Protect-Connect and Power Tool Adapter (sold separately).
- Braking system controls descent and prevents free falls.
- Encapsulating jaw cover protects fingers and clothing from catching in the winch.
- Designed for use with 10 mm to 12.7 mm (3/8 in to 1/2 in) diameter rope of unlimited length.
- Compatible with Arizona Vortex Kit and CMC Triskelion.

Kit Includes

- Stainless steel mounting plate and hardware
- Tripod adapter
- Winch handle
- CMC adjustable strap
- Two (2) CMC Auto-Lock Carabiners
- Waterproof carry case



Mounting the Harken LokHead Winch on the CMC Triskelion

The CMC Triskelion offers several mounting options for the Harken LokHead Winch. Our recommended method is using the LokHead Winch Adapter for quick and easy installation on the inside or outside of the Triskelion legs. In this highly refined system, large ball-lock push pins rapidly secure each component and make it ready for immediate use with the included handle or with a power drill.



Learn more about the Harken Winch Power Tool Adapter at cmcpro.com.

Harken Traction Winch 500



This lightweight, portable self-tailing winch is mounted to a robust adapter plate that makes it simple to use in diverse applications.



Features

- Highly portable, easy to rig, and efficient with a 40:1 power ratio and 2 speeds.
- Pigtail line lead allows easy installation of rope and ensures correct alignment for maximum efficiency.
- Stainless Steel load-carrying gears and pins.
- Unique drum design maximizes grip on rope.
- Sculpted mounting plate has multiple attachment points and is versatile in challenging or remote environments.
- 250 mm (10 inch) winch handle included.

Item #	Max Rope Diameter	Max Rated Load	Weight
733510	12.5 mm (.5 in)	490 kg (1,101 lb)	7 kg (15.4 lb)

Sked-EVAC Industrial Tripod



This heavy-duty tripod is comprised of gold anodized aluminum legs and a cast aluminum head.

Features

- Legs adjust in 127 mm (5 in) increments to a maximum height of 3 m (10 ft).
- Three exceptionally large rigging holes in the head are easy attachment points.
- Cast aluminum feet swivel and come with both sure-grip rubber pads and points for embedding in soft or slippery surfaces.
- Holes in the feet allow the tripod to be bolted into position.
- Included safety chain prevents leg movement and adjusts with an included screw link.
- Carrying bag not included. Sold separately.



Item #	Description	Max Height	Color	Weight
757000	Tripod	302 cm (119 in)	Gold/Red	31.8 kg (70 lb)
757010	Carrying Bag	N/A	Black	1.4 kg (3 lb)



NEW

SL Anchor Straps



NFPA 2500
GENERAL USE

Our Single Layer (SL) Anchor Straps are strong, versatile, and lightweight. Classified to NFPA General Use, these straps have a high breaking strength to withstand heavy loads on the system. They are built to last using proof-loaded steel hardware and durable, weather-resistant polyester webbing. Supple, compact, and quick to deploy, the SL Anchor Straps bend easily around structures and feed smoothly through metal grating.



SL FastLink Anchor Strap

Shared Features

- Compact and lightweight - easy to pack, carry, and deploy.
- Weather-resistant polyester web and proof-loaded hardware.
- Bends easily around structures and metal grating.
- High visibility red with contrasting stitching to aid inspection.
- Combines with CMC's Anchor Sleeves and Edge Guards.



SL Anchor Strap

SL FastLink™ Anchor Strap

- Fast connecting strap with integrated carabiner and quick link.
- Quick link acts as single focal point, mitigating cross-loading.
- MBS: Basket (U): 41 kN, Choker: N/A, End-to-End: 22 kN.



SL Variable Anchor Strap

SL Anchor Strap

- Steel D-Rings pass through one another for easy Choker.
- Simple and effective for anchoring technical rope systems.
- MBS: Basket (U): 62 kN, Choker: 30 kN, End-to-End: 29 kN.

SL Variable Anchor Strap

- Strap length easily adjusts from 91 cm (3 ft) to 213 cm (7 ft).
- Steel adjuster buckle meets strength specifications without requiring a back-up knot.
- Steel D-Rings pass through one another for easy Choker.
- MBS: Basket (U): 54 kN, Choker: 28 kN, End-to-End: 20 kN.

Item #	Product	Size	Length	Weight
201072	SL FastLink Anchor Strap	Small	91 cm (3 ft)	.52 kg (1.14 lb)
201073	SL FastLink Anchor Strap	Medium	152 cm (5 ft)	.59 kg (1.29 lb)
201074	SL FastLink Anchor Strap	Large	213 cm (7 ft)	.66 kg (1.45 lb)
201075	SL FastLink Anchor Strap	X-Large	305 cm (10 ft)	.76 kg (1.68 lb)
201052	SL Anchor Strap	Small	91 cm (3 ft)	.36 kg (.8 lb)
201053	SL Anchor Strap	Medium	152 cm (5 ft)	.44 kg (.96 lb)
201054	SL Anchor Strap	Large	213 cm (7 ft)	.5 kg (1.11 lb)
201055	SL Anchor Strap	X-Large	305 cm (10 ft)	.61 kg (1.34 lb)
201056	SL Anchor Strap	XX-Large	457 cm (15 ft)	.78 kg (1.73 lb)
201042	SL Variable Anchor Strap	N/A	91-213 cm (3-7 ft)	.86 kg (1.89 lb)

Anchor Straps



NFPA 2500
GENERAL USE

A true workhorse in any rope cache, our nylon Anchor Straps are strong, durable, and supple for excellent handling. The Anchor Strap and Variable Anchor Strap feature proof-loaded hardware sized for choker configuration and the FastLink model allows extremely quick installation while mitigating the risks of cross-loading. The Anchor Strap and FastLink offer highly durable double-layer construction.

Shared Features

- Increased resistance to abrasion and other impacts of regular use.
- Sewn-on web keeper allows easy organization and clean rigging.
- Feeds through grates and around hard to reach structures.
- Strong and durable nylon web and proof-loaded hardware.
- Distinct color and contrasting stitching to aid inspection.
- Combines with CMC's anchor sleeves and edge guards.

FastLink™ Anchor Strap

- Fast connecting strap with integrated carabiner and quick link.
- Quick link acts as single focal point, mitigating cross-loading.
- Highly durable with two layers of mil-spec, resin-coated nylon.
- MBS: Basket (U): 48 kN, Choker: N/A, End-to-End: 25 kN.

Anchor Strap

- Steel D-Rings pass through one another for easy Choker.
- Simple and effective for anchoring technical rope systems.
- Highly durable with two layers of mil-spec, resin-coated nylon.
- MBS: Basket (U): 67 kN, Choker: 40 kN, End-to-End: 35 kN.

Variable Anchor Strap

- Strap length easily adjusts from 91 cm (3 ft) to 213 cm (7 ft).
- Steel D-Rings pass through one another for easy Choker.
- Aluminum buckle allows smooth adjustment of single layer web.
- MBS: Basket (U): 52 kN, Choker: 29 kN, End-to-End: 20 kN.

Item #	Product	Size	Length	Weight
201062	FastLink Anchor Strap	Small	91 cm (3 ft)	.59 kg (1.3 lb)
201063	FastLink Anchor Strap	Medium	152 cm (5 ft)	.73 kg (1.6 lb)
201064	FastLink Anchor Strap	Large	213 cm (7 ft)	.86 kg (1.9 lb)
201065	FastLink Anchor Strap	X-Large	305 cm (10 ft)	1 kg (2.2 lb)
201022	Anchor Strap	Small	91 cm (3 ft)	.43 kg (.94 lb)
201023	Anchor Strap	Medium	152 cm (5 ft)	.54 kg (1.2 lb)
201024	Anchor Strap	Large	213 cm (7 ft)	.68 kg (1.5 lb)
201025	Anchor Strap	X-Large	305 cm (10 ft)	.86 kg (1.9 lb)
201026	Anchor Strap	XX-Large	457 cm (15 ft)	1.2 kg (2.6 lb)
201020	Variable Anchor Strap	N/A	91-213 cm (3-7 ft)	.74 kg (1.9 lb)



FastLink Anchor Strap



Anchor Strap



Variable Anchor Strap

Anchor Strap Configurations



Basket (U)

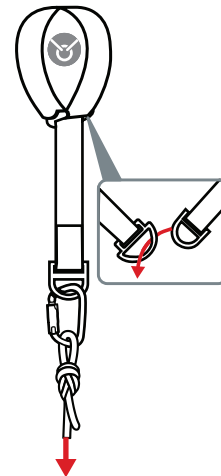

Choker

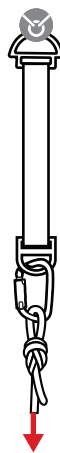

End-to-End



Anchor Strap Sleeve

Protects anchor straps from surface abrasion and the elements, reducing wear, increasing safety, and extending service life. Recommended gear for providing edge protection.



Features

- Made from tough #4 duck canvas with an outside layer of vinyl coated polyester.
- Available in three sizes.

Item #	Size	Length	Weight
294032	Small	61 cm (2 ft)	198 g (.44 lb)
294033	Medium	122 cm (4 ft)	340 g (.75 lb)
294034	Large	183 cm (6 ft)	544 g (1.2 lb)

Load Release Strap



NFPA 2500
GENERAL USE

Makes sizing and tying a load-releasing hitch fast, easy, and dependable.

Features

- Larger D-Ring on load end with enough space for multiple carabiners.
- Wide web and multiple wraps provide a high degree of control during release.
- Comes pre-assembled with one CMC Aluminum Oval Carabiner.
- Made from high-strength web and hardware.

Item #	Extended Length	3 Sigma MBS	Weight
201108	81 cm (32 in)	29 kN (6,519 lbf)	397 g (.9 lb)



FastLink™ Pick-Off Strap



Two carabiners are incorporated directly into this strap, reducing overall weight.



Features

- Includes two ProTech™ Auto-Lock Carabiners with keeper pins (NFPA 2500 – Technical Use).
- Made from the same high-strength web and adjuster hardware as the original CMC Pick-Off Strap.

Item #	Color	Extended Length	Weight
201107	Black	127 cm (50 in)	482 g (1 lb)

Pick-Off Strap



Features

- Allows the rescuer to quickly connect to a victim and then adjust the strap to a desired length.
- A loop at the end of the strap provides a positive grip.
- The integrated Web Keeper allows the strap to be carried on a gear sling without becoming tangled or caught.
- Made of high-strength 45 mm (1.75 in) web.



Designed for use when positioning a victim for a team based or rappel based pick-off.

Item #	Color	Extended Length	Weight
201106	Black	137 cm (54 in)	408 g (.89 lb)

Adjustable Litter Strap



Allows minor adjustments to be made by the tender while a litter is being carried in a low angle evacuation.

Features

- Enables minor adjustments to be made by the tender.
- The buckle extends the strap, preventing rescuer from being pulled down with the litter.
- Can also be used as a pick-off strap.



Item #	Color	Extended Length	Weight
201102	Black	76 cm (30 in)	278 g (.6 lb)



NEW

Texora™ Slings

CE



Texora™ TX/L Compact Sling

Excellent anchor sling or safety lanyard for rescue and rope access. Rated for a four-person load with a 100 kN breaking strength (end-to-end configuration) and constructed with a High Tenacity Polyester (HTP) fiber core, the Compact Sling is extremely strong and robust. An elastic polyester sleeve surrounds the internal load bearing elements for added protection, and easy handling.

Texora™ TX/L Wire Sling

Strong and durable, the TX/L Wire Sling is designed for building versatile anchors in rescue and rope access. Rated for a two-person load, the TX/L Wire Sling has an internal core of galvanized steel wire for high strength and resistance to heat, abrasion, cuts, and impacts. A polyester sleeve surrounds the wire loops to make them easy to handle and prevent them from damaging finished surfaces.

Texora™ Black Mamba Sling

Built for extreme work environments, Texora's Black Mamba represents a breakthrough in technical safety and versatility. Its para-aramid fiber core has a 450°C (842°F) melting point, and high durability. The PES elastane sheath protects and contains the inner fibers in a lightweight, low-profile, and easy to handle package. It's the ideal tool for rescue and access in harsh conditions.

Item #	Product	Length	Weight	Color	Certifications
200400	Texora TX/L Compact Sling	1 m (3.28 ft)	425 g (.9 lb)	Multi-color	EN 795/B; EN 354; CEN TS 16415; ANSI Z359.18
200401	Texora TX/L Compact Sling	2 m (6.56 ft)	800 g (1.7 lb)	Multi-color	EN 795/B; EN 354; CEN TS 16415; ANSI Z359.18
200402	Texora TX/L Wire Sling	1 m (3.28 ft)	540 g (1.2 lb)	Multi-color	EN 795/B; CEN TS 16415
200403	Texora TX/L Wire Sling	2 m (6.56 ft)	1020 g (2.2 lb)	Multi-color	EN 795/B; CEN TS 16415
200404	Texora Black Mamba Sling	.5 m (1.64 ft)	60 g (.13 lb)	Black	EN 795/B; EN 354; CEN TS 16415
200405	Texora Black Mamba Sling	1 m (3.28 ft)	120 g (.26 lb)	Black	EN 795/B; EN 354; CEN TS 16415
200406	Texora Black Mamba Sling	1.5 m (4.92 ft)	180 g (.4 lb)	Black	EN 795/B; EN 354; CEN TS 16415
200407	Texora Black Mamba Sling	2 m (6.56 ft)	240 g (.53 lb)	Black	EN 795/B; EN 354; CEN TS 16415

NEW

CMC Lanyards



EN 354 - ALL LANYARDS
EN 795/B - I-LANYARDS ONLY

Designed for maximum versatility, CMC's Lanyards are excellent multipurpose tools for high angle rope work and technical rescues.

Shared Features

- Supple and durable to support a wide range of applications.
- Smooth handling for easy loading into hardware devices.
- Manufactured with sewn terminations at each end.
- Includes thimbles to maintain loop integrity and prevent cross-loading when connected to hardware.
- Assembled using relaxed rope to minimize variations, twists, and shrinking over time.
- Ideal for rope access, arbor, rescue, and via ferrata.

Static-I Lanyard

- Two sizes allow variety of uses for sternal or ventral connection.
- Dual-certified as lanyards and temporary anchor devices.
- 11 mm Static-Pro™ High Tenacity Polyester sheath and core.

Dynamic Lanyard

- Two sizes allow variety of uses for sternal or ventral connection.
- Dual-certified as lanyards and temporary anchor devices.
- 11 mm Teufelberger Apex nylon rope with dry treated core.
- Designed to reach specified 76 cm (30 in) length when a 10 kg load is applied in accordance with EN 354.

Bullnose Lanyard

- Connects to multiple anchor points and pieces of equipment.
- Overlapping design mitigates end-to-end failure and adds redundancy over "V" style lanyards.
- Two 76 cm (30 in) legs for smooth positioning and progression.
- Central "nose" loop of the Bullnose adds a connection point.
- Wraps around structures and connects back to itself or a harness attachment point.
- 11 mm Teufelberger Apex nylon rope with dry treated core.
- Designed to reach specified 76 cm (30 in) length when a 10 kg load is applied in accordance with EN 354.



Static I-Lanyards

Dynamic I-Lanyards

Bullnose Lanyard

Bullnose Lanyard Harness Connection

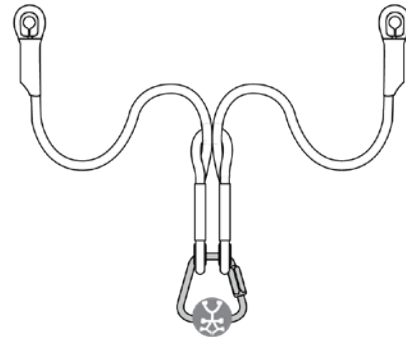

Item #	Product	Color	Length	MBS	Weight
201855	Static I-Lanyard 24"	Orange	24 in (61 cm)	22 kN (4,946 lbf)	100 g (.22 lb)
201856	Static I-Lanyard 30"	Blue	30 in (76 cm)	22 kN (4,946 lbf)	113 g (.47 lb)
201851	Dynamic I-Lanyard 24"	Purple	24 in (61 cm)	22 kN (4,946 lbf)	86 g (.19 lb)
201852	Dynamic I-Lanyard 30"	Green	30 in (76 cm)	22 kN (4,946 lbf)	100 g (.22 lb)
201860	Bullnose Lanyard	Purple	76 cm (30 in)	22 kN (4,946 lbf)	211 g (.47 lb)



ANCHORS & STRAPS

NEW

BOOST™ Foot Loop



The BOOST is a highly adjustable foot loop developed for rope access operations and rescue techniques. It is strong, compact, and easy to use, making it a versatile tool for moving on rope, hauling loads, and performing pick-offs.

BOOST features low profile webbing, smooth adjuster buckles, and an easy one-handed foot closure system. The length is controlled by a custom buckle that balances high holding strength with ease of adjustability. At the base of the foot loop is a durable and collapsible stiffener that assists with foot entry and exit. The elastic foot closure system can be tightened or loosened with one hand. It stays in place when working on rope, aiding, or walking on the ground.

BOOST is built with dedicated rescue functionality. Each component is selected for its high strength to withstand the forces generated during pick-offs. The BOOST's large adjustment range supports a variety of suspended rescue techniques and raising systems. Low friction Dyneema webbing provides a high degree of efficiency in M/A systems, which is especially useful in combination with carabiners or other hardware. The webbing is also pulley-compatible and its compact size enables clean operations and quick stowage.

Features

- Highly adjustable, compact foot loop with rescue functionality.
- Custom aluminum buckle adjusts length from 36 to 57 inches.
- Low friction, high strength Dyneema facilitates rescue pick-offs.
- Easy one-handed closure system securely fastens to footwear.
- Durable and collapsible stiffener assists with foot entry and exit.
- Adjustable and removable keeper tightens web around carabiners.
- Pulley-compatible for building efficient M/A systems.
- Lightweight and low profile for clean operations and stowage.

Item #	Max Height	Weight
201196	92-144 cm (36-57 in)	71 g (.16 lb)



Adjustable Foot Loop



Designed to work with an ascender or rope grab for rapid ascents and rescue pick-offs.

Features

- Connect an ascender to the top loop adjacent to the adjuster buckle.
- Any single loop on the yellow tether can be connected to a harness.
- An extra layer of web holds the foot loop open.
- Smooth adjuster buckles quickly set foot loop size and overall length.



Item #	Color	Extended Length	Weight
201195	Black/Yellow	137 cm (54 in)	136 g (.3 lb)

8 Link



Allows further extension of a Figure 8 Descender from a harness in order to make room for a safety Prusik hitch below the Descender.



Pictured with Figure 8 (sold separately).

Features

- Attaches to the Figure 8 with a girth hitch.
- Multiple carabiner slots allow wide range of adjustment.
- Pocket stitching breaks at 5 kN (1,100 lbf).

Color: Black

Item #	Length	MBS	Weight
201202	46 cm (18 in)	16.9 kN (3,800 lbf)	54 g (.12 lb)

Utility Loops



Permitting versatility when setting anchors, they can be looped over anchor points or used in a basket or choke configuration.



Features

- Made from 25 mm (1 in) tubular web.
- Good grip when tied off with a girth hitch.
- Designed for placing protection when climbing.

MBS: 24 kN (5,400 lbf)

Item #	Size	Color	Length	Weight
201212	Small	Blue	61 cm (24 in)	60 g (.13 lb)
201213	Medium	Orange	91 cm (36 in)	82 g (.18 lb)
201214	Large	Red	152 cm (60 in)	130 g (.29 lb)

Multi-Loop Strap



Tie into an anchor with just the right amount of web.

Features

- Made from 25 mm (1 in) tubular web.
- Pocket stitching breaks at 5 kN (1,100 lbf).

MBS: 16.9 kN (3,800 lbf)

Item #	Color	Length	Loops	Weight
201012	Red	61 cm (24 in)	4	68 g (.15 lb)
201013	Yellow	91 cm (36 in)	8	85 g (.19 lb)
201014	Orange	168 cm (66 in)	18	170 g (.34 lb)



Derby Helo Strap™



This extrication device allows rescuers to rapidly secure and evacuate the subject using two cinch straps with handles. It attaches to a helicopter hoist hook or rescuer harness for short-hauls or hoists.

Features

- Allows rescuer to maintain position behind the subject, securing them around the chest for quick evacuation.
- Two cinch straps with handles adjust quickly to secure the subject.
- Large snap hook and D-ring for fast, secure attachment in adverse conditions.
- Compact system easily stored on aircraft.
- Suited for water and cliff rescues.
- Made of 45 cm (1.75 in) high-strength web.



Item #	Load Capacity	Weight
201942	227 kg (500 lb)	1.68 kg (3.7 lb)

Water Rescue Tether



This tether is designed to serve as a “live bait” water rescue attachment to a PFD.

Features

- Comes with sewn-in brite double-locking connector.
- 25 mm (1 in) tubular web with a built-in bungee.
- Enhances options in rescue situations as a connection between a PFD and a line.

Item #	Relaxed Length	Extended Length	Rated Strength	Weight
201707	72 cm (28.4 in)	117 cm (46 in)	11 kN (2,473 lbf)	227 g (.5 lb)



Tactical Tether



Designed for special ops personnel, this tether connects the wearer to an anchor point in an aircraft or on an edge.

Features

- Comes with sewn-in black double-locking connector.
- 25 mm (1 in) black tubular web with a built-in bungee.
- Includes sewn loop for girth hitching to a harness.

Item #	Relaxed Length	Extended Length	Rated Strength	Weight
201705	85 cm (33.5 in)	117 cm (46 in)	11 kN (2,473 lbf)	204 g (.45 lb)



Azzard Tower Climbing Connector



A quick one-handed connection to towers or other structures when protecting an ascent using a lead climbing technique.

Features

- Custom designed aluminum ring reduces weight and provides a wide, smooth bearing surface for rope.
- 25 mm (1 in) web has wear indicator for easy inspection.
- Double locking connector can be opened with one hand.
- Exceeds OSHA strength requirement of 22.2 kN (5,000 lbf).



Item #	Length	Weight
201828	61 cm (24 in)	255 g (.56 lb)
201829	76 cm (30 in)	278 g (.61 lb)

Y-Shok Lanyard™



An integrated shock absorber offers added protection when climbing or traversing towers and structures.

Features

- One snap hook remains secure while the other is moved to the next location. Each side is an arm's reach in length.
- Lightweight, ANSI-rated snap hooks are double acting but can be opened with one hand.
- Integrated SHOK™ shock absorber reduces impact forces during a fall.
- Includes Stainless Steel Auto-Lock Carabiner.



Item #	Overall Length	MBS	Weight
301017	91 cm (36 in)	22.2 kN (5,000 lbf)	1.8 kg (4 lb)

Bypass Lanyard



Maintain fall protection while climbing or traversing towers and structures.

Features

- One snap hook remains secure while the other is moved to the next location. Each side is an arm's reach in length.
- Lightweight, ANSI-rated snap hooks are double acting but can be opened with one hand.
- Includes an oval screw link for minimum bulk and maximum security.



Item #	Overall Length	MBS	Weight
301010	71 cm (28 in)	22.2 kN (5,000 lbf)	1.3 kg (2.8 lb)







FIRE ESCAPE



IMPROVED

LEVR™ Escape System

AN EXTREMELY COMPACT AND INTUITIVE ESCAPE SYSTEM



NFPA 2500
FIRE ESCAPE SYSTEM

PATENTED

Compact. Reliable. Intuitive. The LEVR Escape System is built around CMC's patented LEVR Descender, a next-generation device that uses its lever-shaped handle for progressive descent control, fast and easy horizontal pay-out, reliable edge transition, and intuitive operation. Designed to assure rapid emergency egress with safe, controllable descent, this escape system is now available with either the gated Flash.G™ Escape Anchor or Flash.2™ Escape Anchor.

System Features

- LEVR Descender provides progressive descent control, easy horizontal payout, smooth edge transition, and hands-free auto-lock for quick exits.
- Flash.2 and Flash.G Escape Anchors are classified to NFPA 2500 - Escape Use for all foreseeable loading scenarios, including tip loading the hook.
- Both Escape Anchors are also classified as Escape Descent Control Devices, allowing for multiple uses.
- Fire Escape Web is made from 100% Technora® fiber for high strength, durability, and heat resistance - Technora chars at 482° C (900° F).
- Using web dramatically reduces storage volume.
- Personal tether and auto-locking carabiner keeps the system attached and ready for deployment.
- Integrates with turnouts and leaves user unencumbered.

System Components

- CMC LEVR Descender reeved with 15.2 m (50 ft) of 11 mm Fire Escape Web (NFPA 2500 – FR Escape Web).
- Flash.2™ Escape Anchor or Flash.G™ Escape Anchor (Both dual classified to NFPA 2500 – Emergency Escape Anchor and Escape Descent Control Device).
- Low-profile Nomex® fabric carry bag compatible with a belt or harness, made for right or left hand deployment.
- ProTech™ Aluminum Auto-Lock Carabiner (NFPA 2500 – Technical Use) with a sewn Para-Aramid fiber tether.



Flash.G



Flash.2

Item #	Anchor Option	Color	Packed Dimensions	3 Sigma MBS	System Weight
500365	Flash.G (Gated)	Red/Black	23 x 8 x 18 cm (9 x 3 x 7 in)	13.5 kN (3,034 lbf)	1.18 kg (2.61 lb)
500360	Flash.2 (Solid)	Red/Black	23 x 8 x 18 cm (9 x 3 x 7 in)	13.5 kN (3,034 lbf)	1.18 kg (2.61 lb)

NOTE: Custom carry bag shapes, including cartridge-style escape bags, are available and can be made to your specifications if quantity requirements are sufficient. Please contact the CMC Customer Support Team for more information.

Designed to assure rapid emergency egress and a safe, controllable descent. The LEVR's ergonomic, low-profile shape is optimized for use with a gloved hand and features an integrated non-slip handle surface.

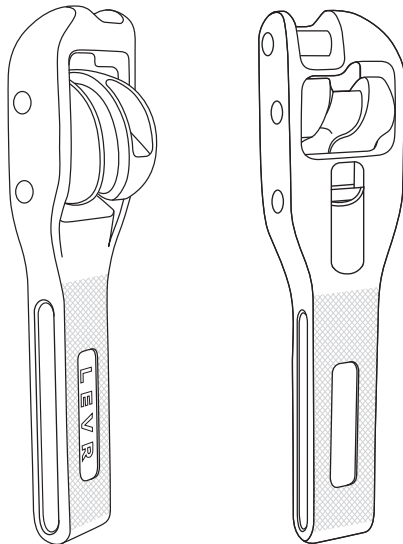

CMC LEVR Descender

- The LEVR Escape System is built around the LEVR descender, a next-generation device that uses a lever-shaped handle for smooth, progressive descent control.
- LEVR provides fast and easy horizontal pay-out for remote anchoring scenarios.
- It delivers smooth and reliable edge transition, minimizing the potential for hang-ups at the window sill.
- LEVR is auto-locking to allow a hands-free exit and it reduces the impact force on the escape anchor if shock loaded during the bailout.
- Compact, reliable, and intuitive, CMC's LEVR Descender is purpose-built for fire escape and last resort emergencies.



NEW

LEVR™ BT Escape System

AN ADVANCED MULTI-PERSON ESCAPE SYSTEM



NFPA 2500
FIRE ESCAPE SYSTEM

PATENTED

Created for advanced users with appropriate training and experience, the LEVR BT Escape System allows firefighters to lower a victim before lowering themselves. While other systems can be modified to lower a victim, the LEVR BT Escape System is purpose-built for the job, with each element specifically designed and certified for efficient execution of multi-person rescue.

System Features

- Allows advanced users to lower a victim and then lower themselves to escape emergency situations.
- Purpose-built for rapid egress and controlled descent during personal escape and partner/victim rescue.
- Flash.G is strong, compact, and dual-certified as an emergency escape anchor and escape DCD.
- BT Deployment Bag has dual-access Velcro side openings to quickly reach either end of the system, allowing attachment of the victim and easy payout.
- Fire Escape Web is 100% Technora® fiber for high strength, heat resistance (900° F char point) and low-volume packability.
- Extremely compact system that integrates with turnout gear and leaves the user unencumbered.

System Components

- CMC LEVR Descender reeved with 15.2 m (50 ft) of 11 mm Fire Escape Web (NFPA 2500 – FR Escape Web).
- Flash.G™ Escape Anchor (Dual classified to NFPA 2500 – Emergency Escape Anchor and Escape Descent Control Device).
- ProTech™ Aluminum Auto-Lock Carabiner (NFPA 2500 – Technical Use) with a sewn Para-Aramid fiber tether.
- BT Deployment Bag for quick access to both ends of the system and easy integration with turnouts.
- Reflective Deployment Pull Tether for rapid extraction of the system, removable if not desired.
- Auto-locking captive eye carabiner sewn to the web tail for quick connection to the victim (NFPA 2500 - Technical Use).



Closed and ready for mounting on a belt or harness with Pull Tether visible for rapid deployment.

Item #	Anchor Option	Color	Dimensions	3 Sigma MBS	System Weight
500363T	Flash.G (With Pull Tether)	Red/Black	23 x 8 x 18 cm (9 x 3 x 7 in)	13.5 kN (3,034 lbf)	1.36 KG (2.99 LB)
500363	Flash.G (No Pull Tether)	Red/Black	23 x 8 x 18 cm (9 x 3 x 7 in)	13.5 kN (3,034 lbf)	1.34 KG (2.95 LB)

NOTE: Custom carry bag shapes, including cartridge-style escape bags, are available and can be made to your specifications if quantity requirements are sufficient. Please contact the CMC Customer Support Team for more information.

Applications

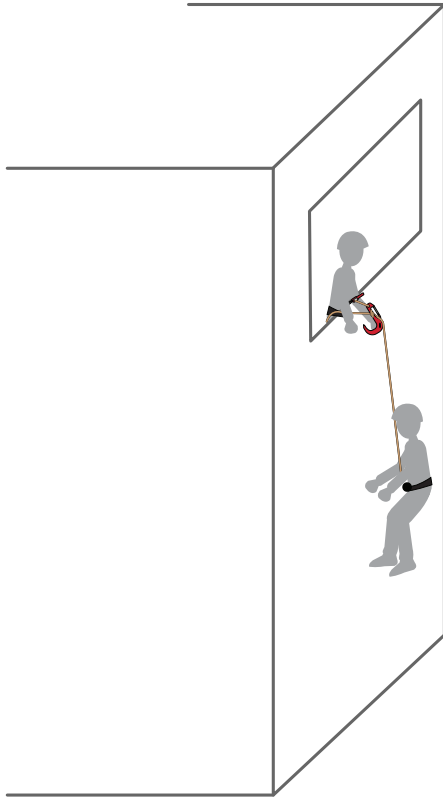

Partner Rescue

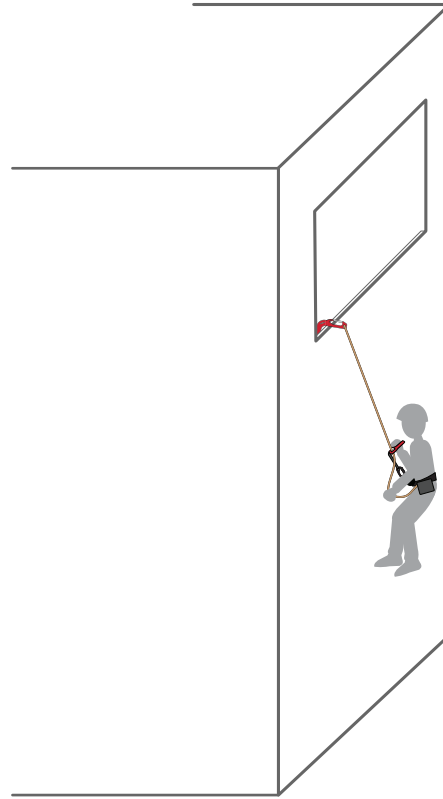

Self Rescue

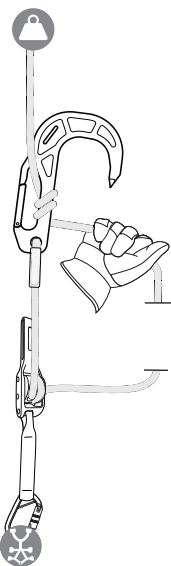

More on Partner Rescue with the LEVR BT Escape System

Created for advanced users, the LEVR BT Escape System allows firefighters to perform the Byrne Technique of lowering a victim before lowering themselves.

With each component designed and classified for efficient multi-person rescue, the LEVR BT Escape System makes it possible to save more than one life in volatile emergency situations when every second counts.



**SCAN TO
LEARN MORE**



NEW

Flash Escape™ Anchor

OPTIMIZED FOR RAPID DEPLOYMENT AND PLACEMENT



NFPA 2500 EMERGENCY ESCAPE ANCHOR
& ESCAPE DESCENT CONTROL DEVICE

PATENTED

CMC's Flash escape anchors are structurally optimized to be strong, robust, lightweight, and low-profile, fitting smoothly into a deployment bag or turnout gear. Their ergonomic shape provides a firm, full-hand grip for rapid deployment and placement.

The Flash escape anchors are rated to 13.5 kN, including the tip, which is angled for superior embedment, helping the anchor remain seated when load is applied and preventing rotation. The wide throat gives the Flash a high degree of compatibility and stability when hooked around load-bearing structures. Remote anchoring is straightforward with two quick loops around the gate on the Flash.G or a girth hitch through the hitching slot on the Flash.2.

The Flash.G and Flash.2 are both classified to NFPA standards as Emergency Escape Anchors and Escape Descent Control Devices. This dual-classification allows advanced users to lower a victim and then lower themselves.

Features

- Structurally optimized to be strong, robust, lightweight, and low-profile.
- Extremely compact, fitting smoothly into a deployment bag or turnout gear.
- Ergonomic shape allows for a firm, full-hand grip for rapid deployment.
- Meets NFPA strength requirements even when loaded in-line with the tip.
- Dual-certified to NFPA standards as Emergency Escape Anchors and Escape Descent Control Devices, allowing emergency rescue of more than one person.
- Tip delivers superior embedment, helping the anchor remain seated.
- Wide throat provides a high degree of compatibility and stability when hooked around structures.
- Attachment eye has 12.5 mm opening to function with most escape lines.
- Allows swift remote anchoring with 2 passes around Flash.G gate or a girth hitch through the Flash.2.
- Flash.G gate is solid, smooth acting, and easy to manipulate without snagging.
- Flash.G is compatible with our rapid deployment tether (sold separately).

Product	Color	Dimensions	3 Sigma MBS	Weight
Flash.2 Escape Anchor	Red	18 x 12 x 1.3 cm (7 x 4.75 x 0.5 in)	13.5 kN (3,034 lbf)	222 g (0.49 lb)
Flash.G Escape Anchor	Red	18 x 12 x 1.2 cm (7 x 4.8 x 0.5 in)	13.5 kN (3,034 lbf)	225 g (0.5 lb)



Flash.2



Flash.G

NEW

Fulcrum Escape™ Belt



NFPA 2500
ESCAPE BELT

PATENTED

Versatile, reliable, and ready for the fireground. The Fulcrum Escape Belt combines fire-resistant para-aramid web with easy-to-use steel hardware in a low-profile Escape Belt.

Features

- Sliding D-Ring attaches to escape systems like CMC's LEVR Escape System.
- Velcro keeper holds Sliding D to the side until its weighted and pulled to center.
- Fixed D-Ring option adds a versatile, rated, load-bearing attachment point.
- Snap-hook closure is fast, secure, and easy to operate with gloved hands.
- Symmetrical design allows belt to be flipped for right or left hand use.
- Black para-aramid web is heat and flame resistant, low profile, and lightweight.
- Triple bartack construction reduces wide stiff points for enhanced comfort.
- Streamlined components prevent web from twisting, folding, or snagging.



Sliding D-Ring



Sliding D-Ring with Fixed D-Ring

Item #	Option	Size	Waist
204002	Sliding D-Ring	Small/Medium	66–97 cm (26–38 in)
204004	Sliding D-Ring	Medium/Large	86–117 cm (34–46 in)
204006	Sliding D-Ring	Large/X-Large	107–152 cm (42–60 in)
204012	Fixed D-Ring, Sliding D-Ring	Small/Medium	66–97 cm (26–38 in)
204014	Fixed D-Ring, Sliding D-Ring	Medium/Large	86–117 cm (34–46 in)
204016	Fixed D-Ring, Sliding D-Ring	Large/X-Large	107–152 cm (42–60 in)

RIT Kit



The reflective cord can be attached at the point of entrance to help firefighters retrace steps or be located by a Rapid Intervention Team in low visibility conditions.



Features

- A carabiner at each end allows partners to connect lines for extended distance.
- Includes reflective RIT line and red ProTech™ Auto-Lock Carabiners with keeper pins.

Bag: Black Nomex

Item #	Line Length	Weight
500345	15 m (50 ft)	.77 kg (1.7 lb)
500347	45 m (150 ft)	1.6 kg (3.5 lb)

Survivor™ 8 Escape System



A lower-cost escape system that makes no compromises on performance.



System Includes

- CMC Survivor 8 Descender
- 15 m (50 ft) of Escape Line
- One ProTech™ Auto-Lock Carabiner
- One ProTech™ Auto-Lock Carabiner with a keeper pin
- Tough Cordura® nylon escape bag

Item #	Line Length	Weight
500400	15 m (50 ft)	1.3 kg (2.9 lb)



FIRE ESCAPE





BAGS & PACKS





NEW

Lotus Tech Pack™

Built for traveling rope technicians, the Lotus Tech Pack is a combination backpack and duffel bag that zips open from all sides and lays flat for maximum access to essential equipment. With 4 exterior pockets and 7 interior pockets, it easily organizes personal kit for the job ahead. Gear is readily visible inside the mesh pockets, which are placed over the contrasting light gray interior. A padded storage pocket is provided for stowing a laptop or tablet. Versatile gear loops and compression straps are sewn into the pack in key areas, enhancing equipment storage.

Features

- Designed to carry personal kit and essential technical gear.
- Combination backpack and duffel bag. Snap buttons stow shoulder straps and Velcro stows duffel handle.
- Accessible from top, bottom, and side, and zips completely flat.
- 4 exterior pockets and 7 interior pockets for equipment organization.
- Padded external pocket for laptop, ipad, or other surface.
- Versatile straps for compression and carrying more equipment.
- Card holder and Velcro strip for patches and other personal identification.
- Durable external coating for superior abrasion and water resistance.
- Sized to fit inside overhead bins on airplanes.



Volume: 50 L (3,052 ci) **Weight:** 2.1 kg (4.6 lb)

Item #	Color
441120	Black/Gray

Opens on the top, bottom, and side to easily reach buried items.

Configure as a duffel or backpack with comfortable, breathable suspension.

Main fabric: 840D (denier) Nylon Double Ripstop (black color) with Carbonate coating on both sides.

Waist belt can be removed when carrying light loads or traveling.



Ground cloth included in lower side pocket for laying out gear.



Zips completely flat to provide immediate access to organized gear.

Sewn gear loops on the outside and removable gear loops inside.

Gray interior provides contrast to see stowed equipment. Fabric: Nylon 210T (tex) Taffeta Ripstop with water-resistant coating.

7 interior pockets: 1 mesh stow, 5 mesh zip, 1 large zip.

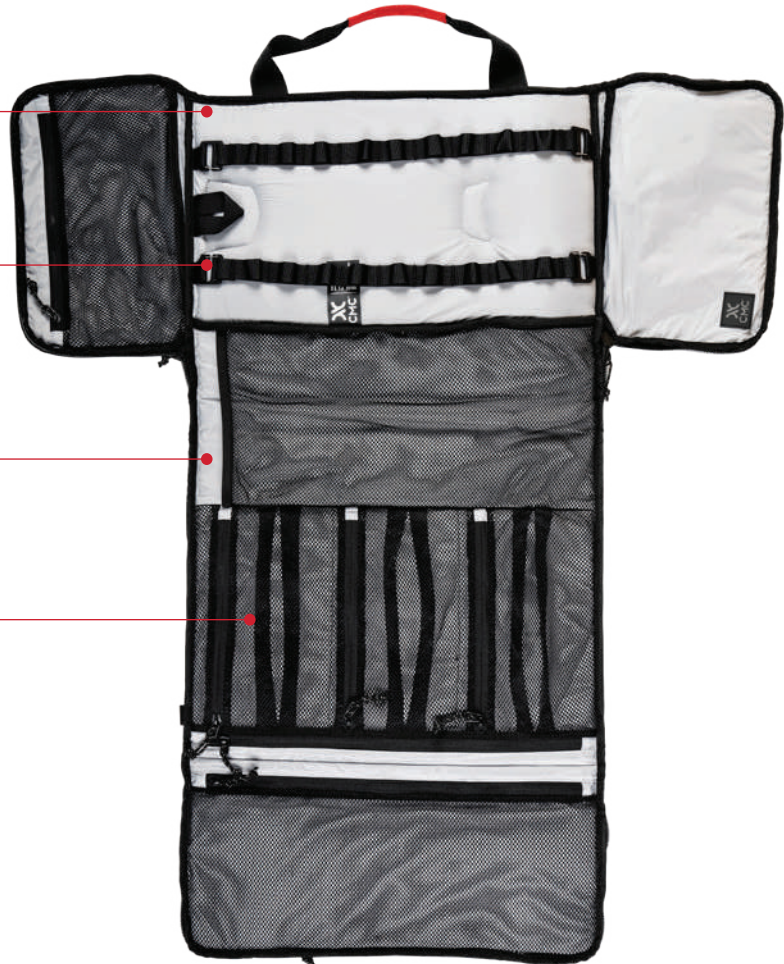

RigTech Pack™

HIGHLY DURABLE AND ULTRA-ORGANIZED

This innovative pack is designed for teams that need to transport a specialized rigging solution. It delivers an uncompromising level of organization for backcountry rescue teams, urban teams, and rope access technicians.

Features

- Contoured shoulder straps, wide padded waist belt, adjustable sternal strap, top and bottom handles.
- Two large, padded external side pockets.
- Internal full-width sleeve designed for storing edge protection.
- Water resistant rip-stop nylon ground cloth easily deploys from top pocket, includes quick-connect buckles and corner carry handles.
- Made of heavy-duty, water-resistant 1,000-denier nylon.

Overall Dimensions: 56 x 46 x 20 cm (22 x 18 x 8 in)

Volume: 42 L (2,550 ci)

Weight: 2.8 kg (6.25 lb)

Item #	Color
441102	Blue
441103	Red



A quick-pull handle opens the full-width main compartment.



Six internal pockets have hook-and-loop keeper straps.

The main compartment remains rigid when open.

Three zippered mesh pockets in front flap for quick organization.

Whitney 2.0™

Built for challenging multi-day missions in remote areas, the Whitney 2.0 offers a large storage capacity, high durability, comfortable suspension, and enhanced features for keeping equipment organized, accessible, and protected from the elements.

Features

- Specially designed pockets fit gloves, helmet, water bottles, and other personal gear.
- Fleece-lined top pocket holds sunglasses or goggles.
- Ground cloth and rain cover included in purpose-built, sub-divided storage pocket.
- Integrated gear loops and MOLLE attachment points on sides and back.
- Top carry handle and pass-through sleeve for optional hydration reservoir (sold separately).
- Made of water and abrasion resistant 1000-denier nylon and 1,000-denier Tarpaulin.

Volume: 50 L (3,052 ci) **Weight:** 2.1 kg (4.6 lb)

Item #	Color
440648	OD Green



Adjustable shoulder and waist straps, and a padded back with aluminum stays.

50 L capacity for multi-day missions.



Sub-divided bottom pocket houses a detachable rain cover and a ground cloth.



Shove-It-Pocket provides quick access to essential items.

Admin compartment has water-resistant liner and zippered mesh pockets.

MOLLE attachment points on sides & back.

Label holder for personal information.

Durable, water-resistant 1,000-denier Tarpaulin on bottom and side pockets reduces wear and abrasion.

Dividable main compartment can be accessed from the top or bottom.



Palisade 2.0™

Shove-It-Pocket is secured by side-release buckles with adjustable straps, allowing compression of pack without restricting access to main compartment.

Bottom of pack is 1,000-denier Tarpaulin for durability and protection.



The Palisade 2.0 has improved capacity, pockets, fabric, and suspension. Designed as a day-pack for 24-hour rescues and SAR training missions, its versatility also makes it a great choice for daily commutes and international travel.

Features

- Constructed with 1,000-denier nylon and 1,000-denier Tarpaulin.
- External water reservoir storage is behind the back pad for easy access.
- Stowable waist belt tucks away behind the back pad.
- Pocket along the back of main compartment stows a laptop, or more water.
- Fleece-lined pocket on top for glasses, goggles, or cell phone.
- Outer zippered compartment for quick access to personal items.
- Exterior MOLLE attachment points.
- Five zippered mesh pockets for easy organization and access.
- Burly top handle for carrying/hauling.

External hydration sleeve stores 2 L water reservoir.



Suspension system offers maximum comfort under heavy loads.

Fleece-lined pocket for glasses, goggles, or phone.



Personal compartment includes a padded pocket for valuables.

Volume: 30 L (1,831 ci)
Weight: 1.66 kg (3.67 lb)

Item #	Color
440633	Red

Rope Bags

CMC Rope Bags have been continually refined over the years to offer innovative features that enhance their performance, durability, and ease of use.



Features

- Sturdy side carry handle for easy loading and unloading.
- Contoured backpack-style shoulder straps for greater comfort when carrying heavy loads (#2 size and up).
- Bag top incorporates rip-stop nylon for easy closure.
- Bottom reach-in pouch provides easy access to rope end.
- Grab handles inside the top can be used to hold the bag open for quicker stuffing.
- Exterior gear loop attachments.
- Clear-view sleeve for rope ID and/or log information.
- Sewn web loops are attached at the base of the bag so that rope can be tied off either internally or externally.
- Made of heavy-duty, water-resistant 1,000-denier Cordura® nylon.

Item #	Model	Color	Volume	Rope Capacity 13 mm (1/2 in)	Rope Capacity 11 mm (7/16 in)	Dimensions (L x D)	Weight
430101	#1	Orange	11 L (700 ci)	30 m (100 ft)	38 m (125 ft)	41 x 20 cm (16 x 8 in)	159 g (.35 lb)
430102	#1	Blue	11 L (700 ci)	30 m (100 ft)	38 m (125 ft)	41 x 20 cm (16 x 8 in)	159 g (.35 lb)
430103	#1	Red	11 L (700 ci)	30 m (100 ft)	38 m (125 ft)	41 x 20 cm (16 x 8 in)	159 g (.35 lb)
430105	#1	Black	11 L (700 ci)	30 m (100 ft)	38 m (125 ft)	41 x 20 cm (16 x 8 in)	159 g (.35 lb)
430107	#1	Yellow	11 L (700 ci)	30 m (100 ft)	38 m (125 ft)	41 x 20 cm (16 x 8 in)	159 g (.35 lb)
430201	#2	Orange	29 L (1,750 ci)	61 m (200 ft)	76 m (250 ft)	76 x 23 cm (30 x 9 in)	372 g (.82 lb)
430202	#2	Blue	29 L (1,750 ci)	61 m (200 ft)	76 m (250 ft)	76 x 23 cm (30 x 9 in)	372 g (.82 lb)
430203	#2	Red	29 L (1,750 ci)	61 m (200 ft)	76 m (250 ft)	76 x 23 cm (30 x 9 in)	372 g (.82 lb)
430205	#2	Black	29 L (1,750 ci)	61 m (200 ft)	76 m (250 ft)	76 x 23 cm (30 x 9 in)	372 g (.82 lb)
430207	#2	Yellow	29 L (1,750 ci)	61 m (200 ft)	76 m (250 ft)	76 x 23 cm (30 x 9 in)	372 g (.82 lb)
430301	#3	Orange	35 L (2,150 ci)	91 m (300 ft)	114 m (375 ft)	81 x 25 cm (32 x 10 in)	426 g (.94 lb)
430302	#3	Blue	35 L (2,150 ci)	91 m (300 ft)	114 m (375 ft)	81 x 25 cm (32 x 10 in)	426 g (.94 lb)
430303	#3	Red	35 L (2,150 ci)	91 m (300 ft)	114 m (375 ft)	81 x 25 cm (32 x 10 in)	426 g (.94 lb)
430305	#3	Black	35 L (2,150 ci)	91 m (300 ft)	114 m (375 ft)	81 x 25 cm (32 x 10 in)	426 g (.94 lb)
430307	#3	Yellow	35 L (2,150 ci)	91 m (300 ft)	114 m (375 ft)	81 x 25 cm (32 x 10 in)	426 g (.94 lb)
430401	#4	Orange	43 L (2,600 ci)	122 m (400 ft)	152 m (500 ft)	81 x 30 cm (32 x 12 in)	449 g (.99 lb)
430402	#4	Blue	43 L (2,600 ci)	122 m (400 ft)	152 m (500 ft)	81 x 30 cm (32 x 12 in)	449 g (.99 lb)
430403	#4	Red	43 L (2,600 ci)	122 m (400 ft)	152 m (500 ft)	81 x 30 cm (32 x 12 in)	449 g (.99 lb)
430601	#6	Orange	122 L (7,450 ci)	198 m (650 ft)	244 m (800 ft)	91 x 36 cm (36 x 14 in)	562 g (1.24 lb)
430603	#6	Red	122 L (7,450 ci)	198 m (650 ft)	244 m (800 ft)	91 x 36 cm (36 x 14 in)	562 g (1.24 lb)

SEE MORE | Learn more about CMC Rope Bags at cmcpro.com



Rope & Equipment Bags™

These bags add a generously sized accessory pouch to the CMC Rope Bag. It's a great way to keep rope and equipment packed together and ready to go for a rope rescue or rope access kit.

Features

- Accessory pouch has zippered closure for quick access and to keep small items secure.
- Removable internal Multi-Loop Strap for attaching connectors.
- Contoured backpack-style shoulder straps for greater comfort.
- Bag tops incorporate rip-stop nylon for easy closure.
- Reach-in pouch on bottom for access to rope from either end.
- Grab handles inside the top can be used to hold the bag open.
- Sturdy side carry handle for easy loading and unloading.



- Exterior gear loop attachments.
- Clear-view sleeve for rope I.D. and/or log information.
- Sewn web loops are attached at the base of the bag so that rope can be tied off either internally or externally.
- Made of heavy-duty, 1,000-denier Cordura® nylon.

Item #	Model	Color	Volume	Capacity (1/2 in rope)	Dimensions (L x D)	Weight
431201	Medium	Orange	39 L (2,400 ci)	161 m (200 ft)	41 x 20 cm (16 x 8 in)	680 g (1.3 lb)
431203	Medium	Red	39 L (2,400 ci)	161 m (200 ft)	41 x 20 cm (16 x 8 in)	680 g (1.3 lb)
431103	Large	Red	48 L (2,900 ci)	91 m (300 ft)	76 x 23 cm (30 x 9 in)	700 g (1.38 lb)

Shasta Gear Bag™

Features

- Top opens fully for access to all parts of the bag.
- Handles on side and both ends.
- Compression straps make bag easier to handle.
- Zippered side pocket for small items.
- Foam insert in bottom preserves shape and protects contents.
- Stores flat when empty.
- Available with optional hideaway shoulder straps.
- Made of heavy-duty, water-resistant 1,000-denier Cordura® nylon.

This large bag with molded quick-grip handles is an ideal choice for carrying the gear needed by firefighters, police officers, or rescue personnel.



Item #	Color	Volume	Dimensions	Weight
440403	Red	87 L (5,300 ci)	36 x 36 x 66 cm (14 x 14 x 26 in)	992 g (2.2 lb)
440423	Red with Hideaway Shoulder Straps	87 L (5,300 ci)	36 x 36 x 66 cm (14 x 14 x 26 in)	1.2 kg (2.5 lb)

Lassen Duffel Bag™

Like our renowned rope bags, our heavy-duty Lassen duffels are constructed from tough water-resistant 1,000-denier CORDURA® nylon to last year after year. The flat-bottom bag features a split-apart comfort grip handle that offers easy access through the double-zippered top. An external zippered side pocket provides additional organization for smaller items like keys, phone, or wallet. A durable molded ID holder is sized to display a business card. It's the perfect lightweight equipment storage bag or companion for packing items back and forth to the station, hauling around as a workout bag, or as a dependable travel carry-on. Available in two sizes.



Item #	Model	Color	Volume	Capacity (1/2 in rope)	Dimensions (L x D)	Weight
440223	Small	Red	36 L (2,200 ci)	161m (200 ft)	51 x 30 cm (20 x 12 in)	454 g (1 lb)
440233	Medium	Red	65.5 L (4,000 ci)	161m (200 ft)	66 x 36 cm (26 x 14 in)	624 g (1.3 lb)

Personal Gear Bag

Features

- Full length external side pocket and two interior zippered pockets (one is fleece lined).
- Main compartment has wrap-around zippered opening.
- Pull-out, hideaway shoulder straps.
- Two external MOLLE strips for carrying carabiners or lashing.
- Also a great for use as a travel or workout bag.
- Made of heavy-duty, water-resistant 1,000-denier Cordura® nylon and Top Gun™ coated polyester fabric.



This full-featured bag is an excellent choice to hold a harness, helmet, gloves, goggles, AZTEK System, hardware, and much more.

Item #	Color	Volume	Dimensions	Weight
441003	Red	33.5 L (2,050 ci)	23 x 33 x 20 cm (21 x 13 x 8 in)	998 g (2.1 lb)
441005	Black	33.5 L (2,050 ci)	23 x 33 x 20 cm (21 x 13 x 8 in)	998 g (2.1 lb)



Truck Cache™



Designed to store, carry, and protect the rigging hardware needed to set up a main line and belay system.

Features

- Carries like a briefcase with molded split-apart handles.
- Hideaway shoulder straps for backpack-style carrying on longer hauls.
- Bag unzips fully to lay flat on ground or be suspended from a vehicle with integrated gutter hooks.
- Interior pockets and hook-and-loop straps are designed to hold and protect a complete system for the CLUTCH, MPD, or traditional RPM (rack, pulley, mariner's hitch).
- Fits easily in truck compartment or behind seat.
- Made of heavy-duty, water-resistant 1,000-denier Cordura® nylon with padded sides.

Dimensions: 64 x 58 x 10 cm (25 x 23 x 4 in)

Item #	Volume	Weight
440541	44 L (2,700 ci)	1.6 kg (3.5 lb)

SEE MORE

Truck Cache™ Kit

Contains all the hardware needed to set up a main line and belay system. **See Page 148.**

Pro Pocket™

Useful personal bag designed to carry accessory equipment while attached to a harness (runners, Prusiks, gloves, etc.).



Features

- Main compartment is large enough to put a hand inside.
- Exterior front and side pockets.
- Exterior gear loops provide attachment points.
- Multiple mounting options including a wide strip for wrapping around a harness and an integrated belt tunnel.
- Exterior reflective strip increases visibility.
- Made of heavy-duty, water-resistant 1,000-denier Cordura® nylon.

Volume: 3 L (200 ci)

Dimensions: 28 x 15 x 10 cm (11 x 6 x 4 in)

Item #	Color	Weight
434103	Red	181 g (.4 lb)
434102	Blue	181 g (.4 lb)
434105	Black	181 g (.4 lb)

Equipment Storage Bag



Made of a padded double layer of Cordura® nylon to protect your hardware like the MPD™ and CMC CLUTCH™ by Harken™, this storage bag features a hook-and-loop closure to keep the bag sealed while allowing quick access. Web handles double as pull tabs for easy opening and can be used to hang the bag from a hook or carabiner.



Item #	Dimensions
432033	20 x 19.5 cm (8 x 7.75 in)

AZTEK ProSeries® Pack



This innovative pack carries the AZTEK System (sold separately). The AZTEK System is collapsed and stored in the pack's two main compartments.

Features

- Constructed with heavy-duty, water-resistant 1,000-denier nylon and 1,000-denier Tarpaulin on the back panel.
- Double-zippered top compartments allow quick and easy access to either side.
- One side is designed to store the AZTEK Omni Set-of-Fours, the other side is made for the personal travel restrict end.
- Integrated harness attachment strap allow pack to be worn around the waist or thigh.
- Upgraded external reflective piping is more durable and provides increased visibility.
- Mesh-panel bottom allows wet components to dry faster
- Outside zippered pocket for carrying small items.
- Exterior gear loops hold up to four rescue-size carabiners.
- Tension-lock buckles allow for secure fit and pack rotation around the hips for quick access.
- Unique Garage Pocket™ on each side conceals cord that bridges the two compartments and protects it from UV exposure and snags.

Item #	Color	Weight
434318	OD Green	425 g (.94 lb)

SEE MORE

AZTEK ProSeries® System

More than 100 rigging solutions packed into a single bag. **See Page 136.**

Set of Fours Pouch

Designed for carrying the AZTEK ProSeries® LT System, this pouch is ideally sized for quick and easy storage and transport of personal M/A systems like the AZTEK LT and Harken Wingman.



Features

- Smooth draw string closure with a semi-rigid ring around the collar.
- Web loop and quick-connect buckle for easy stowage on a harness.
- Made of heavy-duty, water-resistant 1,000-denier Cordura® nylon.

Item #	Color	Weight
432163	Red/Black	127 g (.28 lb)

Outback™ Pouch



A versatile, water-resistant, MOLLE-compatible Pouch for carrying essential equipment. The Outback Pouch has velcro straps for attaching to packs, structures, or belts like the Waist Belt of the Outback Convertible Harness. Made for organizing and carrying personal kit, the Outback Pouch is sized for carabiners, cord, web, and rope devices. It features a zippered front pocket for cell phones and GPS, and provides gear loops on each end for clipping hardware.

Features

- Compact, comfortable to carry, and made with water resistant X-50 fabric.
- Carries personal gear like carabiners, cord, and web.
- MOLLE compatible Velcro straps attach to belts, packs, or structures.
- Zippered front pocket sized to fit cell phones, keys, or GPS.
- Gear loops on each side provide easy access to equipment.

SEE MORE

Outback™ Convertible Harness
See Page 20.



Stuff Bags

Features

- Different colors allow coding of bags for quick retrieval.
- Large bag fits a sit harness, gloves, descender, and carabiners.
- Made of heavy-duty, water-resistant 1,000-denier Cordura® nylon.



These multi-purpose storage bags are great for carrying and organizing equipment.

Item #	Model	Color	Volume	Dimensions	Weight
432301	Small	Orange	3 L (200 ci)	23 x 13 (9 x 5 in)	68 g (.15 lb)
432303	Small	Red	3 L (200 ci)	23 x 13 (9 x 5 in)	68 g (.15 lb)
432307	Small	Yellow	3 L (200 ci)	23 x 13 (9 x 5 in)	68 g (.15 lb)
432101	Large	Orange	7 L (400 ci)	30 x 18 (12 x 7 in)	99 g (.22 lb)
432103	Large	Red	7 L (400 ci)	30 x 18 (12 x 7 in)	99 g (.22 lb)
432107	Large	Yellow	7 L (400 ci)	30 x 18 (12 x 7 in)	99 g (.22 lb)

Throwline Bags (Bag Only)



CMC's UV-resistant, high-strength Throwline Bags are offered in mesh and pack cloth varieties. Pair each bag with the desired Throwline, sold separately ([page 62](#)). For complete Throwline Bag Sets with both the bag and Throwline, refer to our Systems and Kits section ([page 152](#)).



Item #	Size	Model	Color	Capacity W/NFPA Throwline	Capacity W/SRT Throwline	Capacity W/Redi-Line Throwline	Weight
433075	Large	Mesh	Yellow	56 m (185 ft)	33 m (110 ft)	30 m (100 ft)	153 g (.34 lb)
433135	Small	Pack Cloth	Orange	15 m (50 ft)	N/A	N/A	106 g (.23 lb)
433150	Medium	Pack Cloth	Orange	23 m (75 ft)	15 m (50 ft)	14 m (45 ft)	117 g (.26 lb)
433175	Large	Pack Cloth	Orange	30 m (100 ft)	23 m (75 ft)	21 m (69 ft)	150 g (.33 lb)
433574	Small	EZ Stuff	Yellow	23 m (75 ft)	15 m (50 ft)	14 m (45 ft)	130 g (.29 lb)

Water Rescue Gear Bag

Specifically designed for wet conditions, this bag allows quick access to Swiftwater Rescue Technician (SRT) gear.

Features

- Quick drain, breathable mesh sides.
- Durable, reinforced vinyl bottom.
- Cordura® nylon lid has one large pocket for holding fins, and one smaller pocket for accessories.
- Can be carried from the top or side.

Volume: 92 L (5,600 ci)

Dimensions: 56 x 43 x 28 cm (22 x 17 x 11 in)

Item #	Color	Weight
440752	Yellow/Blue	1.1 kg (2.3 lb)



Litter Pack

Convenient pack designed to hold a litter harness, tender straps, web, protective eyewear, and other items that go with a litter.

Features

- Hook-and-loop straps for attachment directly to litter rail.
- Integrated handle and carabiner loops.
- Made of heavy-duty, water-resistant 1,000-denier Cordura® nylon.

Volume: 18 L (1,100 ci)

Dimensions: 51 x 18 cm (20 x 7 in)



Item #	Color	Weight
432401	Orange	354 g (12.5 oz)

SCBA Mask Protector

A durable bag designed to protect an SCBA facemask.

Features

- Hook-and-loop closure keeps the bag sealed while allowing quick access.
- Web handles double as pull tabs for easy opening, and can be used to hang the bag.
- Made of heavy-duty, water-resistant 1,000-denier Cordura® nylon.

Dimensions: 43 x 33 cm (17 x 13 in)

Item #	Color	Weight
770703	Red, Basic	136 g (.3 lb)
770713	Red, Fleece Lined	136 g (.3 lb)



Tactical Leg Bag



The Tactical Leg Bag allows a rappel rope to be mounted securely to an officer's leg. The bag is out of the way when not needed, but in position for an emergency rappel. A descender and anchoring gear can be connected to the rope and stored inside the top of the bag. Wide Hook-and-Loop straps keep the bag from bouncing around when moving quickly.

- Designed to hold 61 m (200 ft) of 9.5 mm (3/8 in) rappel cord.
- Includes stowable waist belt tether with quick-connect buckle for securing to user's harness waist belt, especially useful when bag is loaded with rope.
- Leg straps secured and adjustable with 5 cm (2 in) web and Velcro leg loops.
- Reach-in bottom allows bag to be used easily from both ends.
- Constructed from extra long-life 1,000-denier Cordura® nylon.

Item #	Color	Weight
400100	Black	485 g (1.1 lb)







PERSONAL GEAR



Essential Glove

A glove that lets you do it all, the Essential Glove is feature-rich with touch screen compatible fabric and a thumb sweat wipe. The leather palm protects from heat, moisture, cold, and abrasion; and a second layer reinforces high wear areas to withstand rope work, rappelling, and tool use. The fit is further adjusted and securely fastened by a burly Velcro wrist closure over an elastic cuff. The back of the glove is breathable mesh for keeping hands cool and dry. When not in use, the Essential Glove can be clipped to harnesses and packs through the carabiner hole in the wrist cuff.

Features

- Touch screen fabric on the pointer finger and thumb allow screen use with gloves on.
- Sweat wipe terry cloth material on the thumb is ideal for wiping away sweat and dirt.
- Leather palm is high durability and protects from abrasion and harsh conditions.
- Leather reinforcements provide a second layer that is built to withstand rappelling and tool use.
- Breathable mesh backing keeps hands cool and dry.
- Velcro wrist closure fully adjusts and secures fit.
- Carabiner clip point on the wrist cuff allows quick and easy storage.

Item #	Color	Size
250402	Gray/Black	Small
250403	Gray/Black	Medium
250404	Gray/Black	Large
250405	Gray/Black	X-Large
250406	Gray/Black	XX-Large

Note: CMC gloves tend to run small, if you are between sizes, consider sizing up.



GLOVE SIZING GUIDE

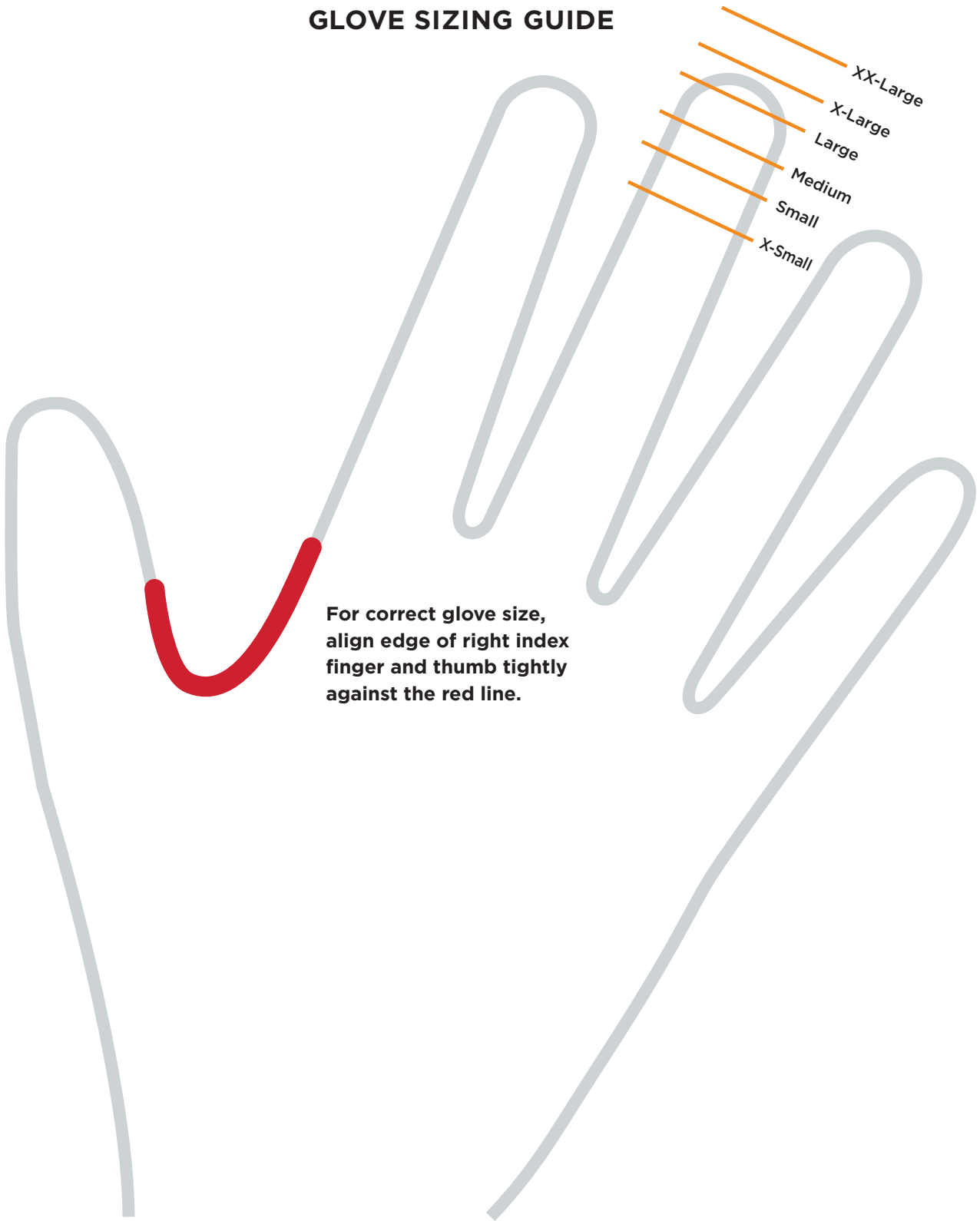

Rappel Glove

This glove offers advanced hand protection with the exceptional dexterity needed for tying knots and working with hardware. A double layer at the thumb web protects hands when rappelling, and the wear-resistant double palm guards against heat, moisture, cold, and abrasion. Its second anatomically segmented layer eases grip fatigue. The back is equally detailed: spandex ventilates and delivers flexibility and comfort, while elastic at the wrist provides a secure fit. When not in use, these gloves can hang on harness gear loops using the carabiner loops sewn into the wrist.

Features

- Double layer of leather at thumb web for protection when rappelling and handling rope.
- Wear-resistant double palm guards against heat, cold, moisture, and abrasion.
- Anatomically segmented second layer eases grip fatigue.
- Spandex back ventilates while adding flexibility and comfort.
- Elastic around the wrist for secure fit.
- Carabiner loops sewn into wrist for stowing on harness.

Item #	Color	Size	Weight
250202	Tan/Black	Small	146 g (.32 lb)
250203	Tan/Black	Medium	146 g (.32 lb)
250204	Tan/Black	Large	146 g (.32 lb)
250205	Tan/Black	X-Large	146 g (.32 lb)
250206	Tan/Black	XX-Large	146 g (.32 lb)
250252	Black	Small	146 g (.32 lb)
250253	Black	Medium	146 g (.32 lb)
250254	Black	Large	146 g (.32 lb)
250255	Black	X-Large	146 g (.32 lb)
250256	Black	XX-Large	146 g (.32 lb)

Note: Tan color may vary from light to dark. CMC gloves tend to run small, if you are between sizes, consider sizing up.



Also available in black!

Princeton Tec® Eos II Intrinsically Safe Headlamp



CLASS 1, DIVISION 1
GROUPS A, B, C, AND D

A rugged, self-contained, waterproof headlamp designed to offer premium performance in the most demanding conditions.

Features

- Advanced circuitry regulates power output for consistent brightness in each of the headlamp's two modes.
- Maxbright LED lamp puts out 170 lumens and a spot beam that reaches up to 60 meters.
- Three AAA alkaline batteries included. 100-hour burn time.
- Comes with a standard nylon headstrap, 3M Dual Lock, and a rubber strap that stays securely in place on a helmet or hard hat.

Item #	Weight
130625	105 g (.23 lb)



Princeton Tec® Apex Headlamp



This extremely bright, waterproof headlamp has been a favorite of cavers and outdoor enthusiasts for years.

Features

- Waterproof headlamp with regulated and dimmable LEDs.
- Maxbright LED and four Ultrabright LEDs deliver 650 lumens.
- Produces a powerful spot beam or bright flood using two switches that make changing modes intuitive.
- Proprietary heatsink technology allows LEDs to burn brighter and longer.
- Compatible with 4 AA Alkaline batteries (included), and Lithium or NiMH rechargeable batteries
- 12 hour burn time

Item #	Weight
130701	279 g (.62 lb)



Kask Superplasma HD Helmet



ANSI Z89.1

CSA Z94.1



HI-VIZ

A lightweight, compact, and extremely comfortable helmet designed for professional rescue and rope access operations.

Features

- Outstanding ventilation through ten air intakes protected by aluminum anti-intrusion grills to deflect debris and water.
- Outer shell is made of high-density ABS plastic designed to withstand significant impact.
- Chinstrap fastening points with 4.98 kN (1,119 lbf) breaking strength.
- Special ring on side retractor strap for fastening helmet to a harness.
- Advanced shape of inner shell for improved durability and better fit.
- Up-N-Down system adjusts height and inclination, allowing correct positioning as well as proper fit.
- Polygiene® treated inner padding inhibits growth of odor-causing bacteria.
- Hi-Viz version features fluorescent colors and is equipped with reflective stickers and glow-in-the-dark headlamp clips to maximize visibility in dark conditions.
- SuperPlasma Visors are available in three lens styles for added protection (sold separately).

Head Size: 51-62 cm (20-24.5 in)

Weight: 450 g (.99 lb)

Item #	Color
346200	White
346201	Orange
346202	Blue
346203	Red
346205	Black
346207	Yellow
346220	Hi-Viz White
346223	Hi-Viz Red
346226	Hi-Viz Lime
346227	Hi-Viz Yellow



Optional Visor

Weight: 70 g (.16 lb)

Item #	Color
346409	Smoke
346415	Clear
346425	Mirror

Kask Zenith X2 Helmet

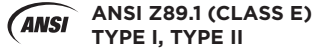

Compact, hi-tech safety helmet made to exceed global safety standards with exceptional protection from impact and penetration. Includes advanced materials for greater energy absorption, a self-adjusting ratchet system for a secure and comfortable fit, and integrated slots for eye and face protection.

Features

- HD Polypropylene for greater energy absorption and protection.
- Low density inner core for top impact protection.
- High density inner shell protection for all-around impacts.
- Moisture-wicking fabric with silver ion antibacterial treatment.
- Padding attachment system enhances durability and ease of replacement.
- Patented size adjustment system for self-adapting comfort.
- New rear adjustment points for a more personalized fit.
- Lime color clasp indicates that the helmet meets EN 12492.
- Integrated slots ready for eye and face protection.
- Ear plug hooks, earmuff slots, and replaceable headlamp clips.



Head Size: One Size Fits Most | **Weight:** 470 g (1.04 lb)

Item #	Color
346310	White
346313	Red

Kask Helmet Decal Set

Customize a Kask Helmet while increasing night visibility.

Features

- High-quality reflective 3M decals tested and approved by helmet manufacturer.
- Available in three versions: SAR, Fire Rescue, and USAR.
- Each version includes one sheet of decals that have been die-cut for easy installation.
- Includes blank decals that can be customized with a permanent marking pen.

Color: Reflective Silver/Black

Item #	Option
346701	Firefighter
346702	SAR
346703	USAR



Sunbrero™

This popular brim fits over a helmet to block sun and rain from the face, ears, and back of neck. The lightweight and durable design has proven itself in the field over many years.

Features

- Black under-surface eliminates sun reflection.
- Wide elastic band with hook-and-loop adjustable strap grips securely to headlamp retainer clips on most helmets.

Weight: 136 g (.28 lb)

Item #	Color
492155	Black
492159	Gray



CMC Pro Team Tee

Features

- Premium 100% cotton t-shirt
- Color: Black
- Screen printed with CMC logo
- Tag-free label for comfort.
- Silkscreened in California.
- Package-rolled in our recyclable CMC Shirt Sleeve.

Item #	Style	Size
494262	Mens	Small
494263	Mens	Medium
494264	Mens	Large
494265	Mens	X-Large
494266	Mens	XX-Large
494281	Womens	X-Small
494282	Womens	Small
494283	Womens	Medium
494284	Womens	Large
494285	Womens	X-Large



Mens



Womens

CMC Stainless Steel Cup



CMC's Stainless Steel Cup is made of high quality, 18/8 food-grade stainless steel. Pint-sized, stackable, durable, reusable, and convenient for travel. Satin black finish for a smooth look and feel.

#853117 | Black

CMC Insulated Camper Mug



CMC's Insulated Camper Mug is a 12 oz double wall 18/8 stainless steel thermal mug with a durable powder coated finish, copper vacuum insulation, clear push-on lid, and swivel closure.

#853201 | Black

CMC Patch



The CMC Patch has a Velcro backing for use with MOLLE or similar Velcro attachment systems. Diameter: 7.62 cm (3 in).

#491053 | Black

CMC Sticker



White reflective sticker displaying the CMC logo. Ideally sized for a helmet or other equipment at 4.4 x 4.4 cm (1.75 x 1.75 in).

#491014 | White Reflective

CMC Pro Team Insulated Bottle

This 18/8 stainless steel, powder coated bottle has all the bells and whistles - including double-wall vacuum insulation, a one-hand push-button lid with grit guard, and an over-molded finger/carabiner loop. Great for working at height. Volume: 0.62 L (20.9 oz)

#853151 | Black



CMC Trucker Hat



A mid-profile, trucker-style hat made from cotton canvas and polyester mesh with adjustable snap back. One size fits most.
Color: Gray

#492275 | Gray | Adjustable

CMC Pro Team Hat



Stays clean, cool, and dry. Moisture wicking material has stain block technology. Light weight fabric for greater comfort.

Color: Black

Item #	Size	Circumference
492242	Small/Medium	17.1-18.4 cm (6.75-7.25 in)
492264	Large/X-Large	18.1-19.4 cm (7.13-7.63 in)

CMC Doo-Rag



Can be worn under a helmet. Built-in sweat band for extra absorbency. Printed with the CMC logo on the front and tack tail.
100% cotton.

#492005 | Black

CMC Buff



This custom BUFF highlights CMC's logo and our dedication to versatile equipment. BUFF Multifunctional Headwear is engineered with a 4-Way, seamless, ULTRA STRETCH fabric that features UPF 50 protection and 100% recycled REPREVE® Microfiber.

#492025 | Black



California Mountain Company

In 1978, Jim Frank founded California Mountain Company (now CMC) to ensure that rescue professionals had specialized equipment for safe and effective rescue operations. Since then, we've stayed true to our mission to protect professionals working in high-risk environments by providing trusted life safety equipment and education. Our California Mountain Company™ heritage line honors our roots and our dedication to those serving the rescue community.

78 Pack™



With its roll-top design, roomy interior and heavy duty nylon construction, this everyday pack takes the scouting packs of yesteryear to a whole new level. It features a front zippered pocket, external straps and multi-loop attachment points for carrying extra gear, and a padded internal laptop sleeve.

Dimensions: 48 x 30 x 15 cm (19 x 12 x 6 in)

Volume: 28.7 L (1,750 ci) | **Weight:** 725 g (1.6 lb)

#442102 | Blue



Mountain Heritage Hat



This mid-profile, trucker-style hat pays tribute to the 1980s, when CMC was just starting. Made from cotton canvas and polyester mesh, it has an adjustable snap back. One size fits most.

#492322 | Navy Blue | Adjustable

Mountain Mug



CMC partnered with Ohio based American Mug & Stein Co. to create this handcrafted, heavy ceramic mug with a distinctive look and feel. Carries the California Mountain Company heritage logo.

#853200 | Navy Blue | 16 oz.



PERSONAL GEAR





PATIENT CARE & TRANSPORT



Stainless Steel Rescue Litter



This refined design represents a complete re-thinking of the classic Stokes military-style litter.

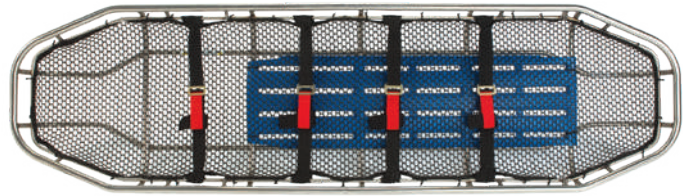

Features

- SträtLoad™ Attachment Points keep connecting carabiners and bridle inside top litter rail.
- A full 1-inch diameter top rail makes litter easier to handle when carried for extended periods.
- Durathene™ netting bottom eliminates cuts and scrapes caused by broken wires.
- Back support is molded, high-density polyethylene.
- Steep sides allow a narrower overall litter, while maintaining the same bed width to accept standard-size backboards.
- Narrow width and rounded ends allow greater maneuverability in tight locations.
- Includes four quick-attachment litter straps.

3 Sigma MBS: Vertical: 24.9 kN (5,598 lbf) | Horizontal: 13.7 kN (3,080 lbf)

Item #	Model	Length	Width	Depth	Load Rating	Weight
726100	Tapered	212 cm (83.5 in)	58 cm (23 in)	18 cm (7.25 in)	11 kN (2,473 lbf)	14 kg (31 lb)
726101	Rectangular	212 cm (83.5 in)	58 cm (23 in)	18 cm (7.25 in)	11 kN (2,473 lbf)	14 kg (31 lb)

Stainless Steel Split-Apart Rescue Litter



A split-apart version of the Stainless Steel Rescue Litter.

Features

- All features of the Stainless Steel Rescue Litter.
- Quick and easy to assemble and disassemble.
- Two sections hinge together at bottom, secured by integrated threaded and locking collars on top rail.
- Locking collar design eliminates pins that can become lost or damaged.
- Includes four quick-attachment litter straps.
- Length when nested is less than 114 cm (45 in).



3 Sigma MBS: Vertical: 24.9 kN (5,598 lbf) | Horizontal: 13.7 kN (3,080 lbf)

Item #	Model	Length	Width	Depth	Load Rating	Weight
726103	Tapered	212 cm (83.5 in)	60 cm (23.5 in)	19 cm (7.5 in)	11 kN (2,473 lbf)	15 kg (33 lb)
726104	Rectangular	212 cm (83.5 in)	60 cm (23.5 in)	19 cm (7.5 in)	11 kN (2,473 lbf)	15 kg (33 lb)

Titanium Rescue Litter



Impressively light and strong, the titanium litter is 7.7 kg (17 lbs) lighter than the Stainless Steel Rescue Litter.

Features

- Tapered shape with SträtLoad™ Attachment Points and all of the other features of the Stainless Steel Rescue Litter.



3 Sigma MBS: 24.9 kN (5,598 lbf) | Horizontal: 13.7 kN (3,080 lbf)

Item #	Model	Length	Width	Depth	Load Rating	Weight
726112	Tapered	212 cm (83.5 in)	58 cm (23 in)	18 cm (7.25 in)	11 kN (2,473 lbf)	6.3 kg (14 lb)

Titanium Split-Apart Rescue Litter



The premium choice in basket stretchers. Whether you are backpacking in or carrying it on a helicopter, the strong and lightweight Titanium Split-Apart Litter nests for optimum storage and packing, then assembles quickly in the field for efficient rescues.

Features

- Half the weight of the Stainless Steel Split-Apart Litter.
- Nested length is less than 114 cm (45 in).
- Includes SträtLoad™ Attachment Points and all of the other features of the Stainless Steel Spit-Apart Rescue Litter.



3 Sigma MBS: Vertical: 24.9 kN (5,598 lbf) | Horizontal: 13.7 kN (3,080 lbf)

Item #	Model	Length	Width	Depth	Load Rating	Weight
726117	Tapered	212 cm (83.5 in)	60 cm (23.5 in)	19 cm (7.5 in)	11 kN (2,473 lbf)	7.5 kg (17.5 lb)



The Advantage of SträtLoad™ Attachment Points

The patented SträtLoad Attachment Points keep an attaching carabiner and lifting bridle on the inside of the litter's top rail, protecting them from abrasion along cliff faces or walls. SträtLoads also orient the direction of pull along the spine of the carabiner, where it is strongest. SträtLoads are 6 mm (.25 in) thick with a rounded inside edge, allowing the option of a soft attachment. SträtLoads are standard on all stainless steel and titanium litters.



Disaster Response Litter

Features

- Tubular runner rails extend the full length of bottom to provide a durable, strong base.
- Powder-coated steel construction.
- Durathene™ netting insert.
- A cost-effective option when litter is only needed for occasional use.
- The narrower confined space version fits through tight openings.

This medium-duty, economical litter has been designed for durability and versatility.



Item #	Model	Color	Dimensions	Load Rating	Weight
726300	Tapered	Black	12 x 62 x 18.5 cm (83.5 x 24.25 x 7.25 in)	4 kN (900 lbf)	12.7 kg (28 lb)
726301	Rectangular	Black	12 x 62 x 18.5 cm (83.5 x 24.25 x 7.25 in)	4 kN (900 lbf)	12.7 kg (28 lb)
726305	Confined Space	Black	12 x 62 x 18.5 cm (83.5 x 24.25 x 7.25 in)	4 kN (900 lbf)	12 kg (26 lb)

Traverse Advantage Plastic Litter

Internal stainless steel frame with polyethylene shell that protects the patient and provides a smooth surface for sliding.

Features

- SträtLoad™ Attachment Points.
- Shell attaches to top rail, with cutouts for carrying.
- Second rail is unobstructed for patient tie-in.
- 22 mm (.875 in) top rail is comfortable to carry.
- Closed-cell foam patient pad prevents absorption of fluids and stands up to strong cleaning.



Item #	Dimensions	Load Rating	Weight
726125	216 x 60 x 19 cm (85 x 23.5 x 7.5 in)	11.1 kN (2,500 lbf)	13.2 kg (29 lb)

Traverse Mule II Litter Wheel

Provides great leverage and easy transport with a large, lightweight, all-terrain wheel.



Mule without Handles

Deployed: 81 x 66 x 70 cm (32 x 26 x 27.5 in)

Stored: 81 x 66 x 47 cm (32 x 26 x 18.5 in)

Load Limit: 227 kg (500 lb)

Mule with Handles

Deployed: 245 x 70 x 70 cm (96.5 x 27.5 x 27.5 in)

Stored: 93 x 70 x 47 cm (36.5 x 27.5 x 18.5 in)

Load Limit: 227 kg (500 lb)

Features

- Ratchet securing system with two straps and two rubberized hooks locks down any rigid litter.
- ATV wheel tracks easily and absorbs shock for added patient comfort.
- Available with or without handles.
- Adjustable handles lock into position with quick-release pins on wire lanyard.
- Aluminum frame with stainless steel axle.
- Wheel detaches quickly and fits inside frame for compact storage and transport.

Item #	Model	Weight
331601	Mule without Handles	19 kg (41 lb)
331602	Mule with Handles	23 kg (51 lb)

Vertical-Lift Litter Harness



Designed for use in confined spaces and tight openings where lift usually ends with a 90-degree transition.



Features

- Eases transition over an edge when high anchor point is not available.
- Improves patient care while reducing risk and human power requirements.
- Unique spreader bar allows litter to pivot between side straps as head of litter clears edge.
- Straps with adjustment buckles are made of 25 mm (1 in) flat web with tensile strength of 26.7 kN (6,000 lbf).
- Delta Quick-Link connection point included.

Item #	Color	Weight
724133	Orange	1.3 kg (2.8 lb)



Litter Shield



Protects patient's face and head from falling rocks, brush, and inclement weather without compromising access or visibility.



Features

- Mounts on top litter rail and pivots to nest inside litter for storage and transport.
- Quick-release pin allows complete removal.
- Sides secure with hook-and-loop straps.
- Molded from Lexan® for high impact resistance, clarity, and durability.
- Reduces need for other head and face protective gear.
- Proven through years of use in the field.

Item #	Description	Weight
740000	Litter Shield	1.4 kg (3.1 lb)
740011	19 mm Clamp for Disaster Response, Gazelle & Junkin litters	77 g (.17 lb)
740017	22 mm Clamp for Traverse Advantage Litter	68 g (.15 lb)
740016	25 mm Clamp for Stainless and Titanium Litters	68 g (.15 lb)
740012	35 mm Clamp for plastic-covered rails - Ferno type	85 g (.19 lb)
740015	Replacement Pin	60 g (.13 lb)

Litter Shield Plus



A taller shield for protecting patients from further trauma during litter evacuations and carry-outs.



Features

- Mounting bracket fits most litters and eliminates need for a railing clamp.
- Sides secure with hook-and-loop straps.
- Helps reduce “closed-in” feeling experienced by some patients.
- Molded from Lexan® for high impact resistance, clarity, and durability.
- Reduces need for other head and face protective gear.

Item #	Model	Weight
740005	For CMC Stainless and Titanium Litters	2.7 kg (6 lb)

Patient Tie-In System



Save critical patient packaging time with this quick and easy system for securing a patient. The color-coded web and snap ring closures allow intuitive, safe, and efficient patient tie-in.

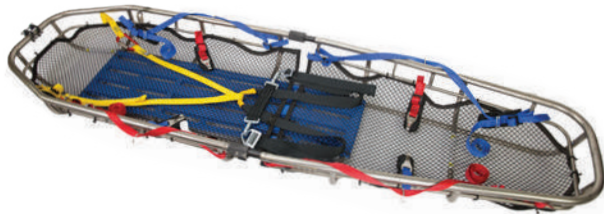

Features

- Sold as a kit with the Pelvic Harness included to support patient's weight when litter is placed in head-up position.
- Versions available for one-piece and two-piece litters.
- Lightweight and adjustable for patient comfort.
- Can be used for patient on backboard.
- Color-coded web makes securing patient quick and intuitive.
- Included stuff bags for stowage of straps and harness.
- The Tie-In System (one or two piece) and the Pelvic Harness can also be ordered individually upon request.

Item #	Description
500701	Kit, Patient Tie-In, One-Piece Litter
500702	Kit, Patient Tie-In, Two-Piece Litter

Skedco Oregon Spine Splint II



A vest-type extrication and immobilization device designed for use with the Sked Stretcher.

Features

- Immobilizes head and cervical spine and functions as a long spine board when used with a Sked Stretcher (not included).
- Includes shoulder board to prevents compression of patient in Sked Stretcher
- Fits inside a rolled-up Sked Stretcher.
- X-ray translucent and decontaminable.

Item #	Color	Weight
753001	Orange	4.8 kg (10.6 lb)

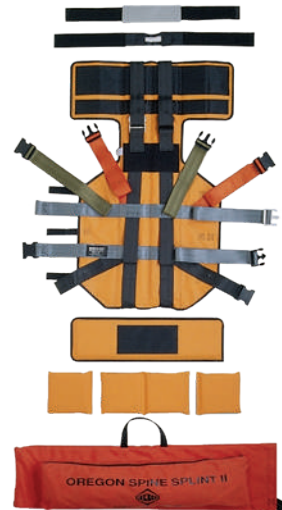

ProSeries® Litter Harness



NFPA 2500
GENERAL USE

Features

- Parachute buckles on each leg allow independent adjustment.
- Litter can easily be set at best angle for conditions or patient comfort.
- Heavy-duty O-ring tie-in point.
- Includes 3 m (10 ft) tender line of CMC Static-Pro and storage bag.
- Carabiners sold separately.



Item #	Color	3 Sigma MBS	Weight
724121	Black	66 kN (14,837 lbf)	2.3 kg (5.1 lb)

Rescue Litter Harness



Designed for high-angle rescues where minimum weight is important, such as backcountry rescues and air operations.

Features

- Cam buckles on each leg allow independent adjustment.
- Litter can easily be set at best angle for conditions or patient comfort.
- System ropes can be attached directly to included 54 kN (12,139 lbf) Delta Quick-Link.
- Includes 3 m (10 ft) tender line of CMC Static-Pro and storage bag.
- Carabiners sold separately.

Item #	Color	MBS	Weight
724131	Red/Blue	32 kN (7,194 lbf)	1.4 kg (3 lb)

Low-Angle Litter Harness



Features

- Center strap provides an adjustable backup to the side straps.
- Side straps attach to cross bars below top litter rail.
- Made of 44 mm (1.75 in) flat web with tensile strength of 33.3 kN (7,500 lbf).
- Fits most litters.
- Nylon storage bag included.
- Carabiners sold separately.

Fits on the outside of a litter to provide greater stability than setups with carabiners connected directly to the litter railing.



Item #	Color	Weight
724123	Black	992 g (2.2 lb)

HMH Sked® Stretcher



Compact, decontaminable, durable, and adaptable stretcher designed for use in mass-casualty and hazardous materials incidents.

Features

- Can be rapidly deployed by one person and dragged over virtually any terrain, including stairwells.
- Made of medium-density polyethylene plastic that withstands high temperatures and is unbreakable at temperatures down to -84° C (-120° F).
- Can be stored flat on pallets with straps packaged separately for quick movement to an incident.
- Patient can quickly be rolled onto stretcher and pulled out of the hot zone, even if rescuer is wearing Level A or Level B protective suit.
- 50 mm (2 in) side-release buckles work with thick gloves.
- Polypropylene straps are resistant to chemicals.

Item #	Color	Weight
752507	Yellow	6.1 kg (13 lb)

Litter Flotation Collar



A lightweight collar to provide flotation assistance during patient handling.

Features

- Two-piece design for quick installation on most litters.
- Provides 290 N (65 lb) of buoyancy to keep patient afloat.
- Made of durable, latex-free PVC (vinyl) coated polyester.

Item #	Color	Length	Weight
726210	Yellow	130 cm (51 in)	1.4 kg (3.06 lb)

Litter Cover



Designed for use by teams that need to mount a litter on the outside of their response vehicle.

Features

- Constructed from exterior-grade vinyl material.
- Offers protection from rain and UV, but is not fully waterproof.
- Oversized to allow easy removal and storage of bulky items.

Item #	Color	Weight
724104	Orange	3 kg (6.6 lb)

Sked® Stretcher Flotation System



A flotation system for the Sked Stretcher, designed to keep the patient nearly vertical.

Features

- Designed for loading a patient in the water into the stretcher.
- Self-righting to keep patient's head above water, even in rough conditions.
- Fits full size and pediatric Sked Stretchers.

Item #	Color	Weight
756001	Orange	10.2 kg (22.5 lb)



CMC/Skedco® Drag-N-Lift Harness™



NFPA 2500
CLASS III VICTIM EXTRICATION DEVICE

PATENTED

Features

- Vertical lift attachment points for confined space extrication. Designed for use with the included spreader bar (required).
- Drag sheet becomes rigid when curved around patient.
- Integrated harness assembly restrains patient securely.
- Padded back and leg loops provide patient comfort.
- Color-coded straps and Steel Snap-Hook Buckles expedite patient packaging.
- Handles on sides, top, and bottom facilitate movement and positioning.
- X-ray translucent and easy to clean.
- Heavy-duty Cordura® nylon storage bag included.



A quick extrication device that is designed for use in confined spaces when spinal immobilization is not a priority or requirement.

Dimensions (Packed): 122 x 25 cm (48 x 10 in)

Item #	Item	Color	Weight
721805	Drag-N-Lift Harness With Spreader Bar	Orange/Gray	6.35 kg (14 lb)

SEE MORE

Spreader Bar

A Spreader Bar is required for proper use. It is included with the Drag-N-Lift & sold separately. **See Page 51.**

Half-Sked® Patient Drag



Developed for extricating patients from spaces that are too tight or restricted for use of full-size stretchers.

Features

- Allows rescuers to bend patient at the hips for greater flexibility in turning corners in caves or confined spaces.
- 50 mm (2 in) chest and leg straps with side-release buckles make patient packaging quick and secure.

Item #	Color	Weight
752008	Orange	3.7 kg (8.1 lb)



Sked® Basic Rescue System



Compact storage, ease of use, and flexibility of transport make this system popular with fire departments, rescue squads, the military, and ski patrols.

Features

- Made from a single sheet of heavy plastic, stretcher becomes rigid when folded around patient.
- Variety of included handles and straps allow stretcher to be carried, lifted by rope system or helicopter, or towed with stretcher sliding on its smooth bottom surface.
- Storage bag has a length of 91 cm (36 in) and a diameter of 23 cm (9 in).



System Includes

- SKED Stretcher
- Cordura® nylon backpack
- Tow straps
- 2 horizontal lift slings
- Vertical lift sling
- 1 large steel carabiner
- 4 removable web handles

Item #	Color	Weight
752001	Orange	8.2 kg (18 lb)

Sked® Basic Rescue System with Cobra™ Buckles



The Sked Basic Rescue System upgraded with aluminum Cobra quick-connect buckles.



Features

- Cobra buckle system eliminates need to weave web through buckles when packaging a patient, often cutting time in half.
- Cobra quick-connect buckles are rated to 13.3 kN (3,000 lbf) and prevent inadvertent release when under tension.

Item #	Color	Weight
752201	Orange	8.6 kg (19 lb)

Sked-Evac Cobra™ Buckle Conversion Kit



Complete conversion kit for switching Sked Stretcher steel buckles to aluminum quick-connect buckles. The quick-connect option allows patient packaging to be done in about half the time.

Kit includes

- Six aluminum quick-connect buckles with web straps.
- Straps girth hitch to Sked Stretcher for easy installation.
- Allows patient packaging to be performed in approximately half the time by replacing web feeding with quick-connect.

Item #	Color	Weight
752060	Black	.9 kg (2 lb)





Helitack AirBag™



NFPA 2500
LITTER

Designed for rapid patient extraction and transport using helicopter short-hauls or hoists in situations where a litter is required.

Features

- Compatible with most backboards, rigid litters, and vacuum splints.
- Bi-lateral patient access ports for quick patient access during operation.
- Adjustable hood helps to protect the patient's face.
- Two steel D-ring attachment points.
- Two Internal straps with aluminum quick-connect buckles.
- Three color-coded packaging straps with side-release buckles.
- Ten high-visibility handles for carrying and positioning.
- Full-length Safety-Glo accent strips for enhanced night visibility.
- Eight adjustable bridle straps.
- Two side stowage pockets for bridle.
- Compact design stores in a 53 x 28 cm (21 x 11 in) space.
- Includes quick-detachable storage bag.
- Made of heavy-duty 1,000-denier Cordura® nylon.



Item #	Dimensions	Color	Weight
724247	53 x 28 cm (21 x 11 in) Stored in Bag 234 x 76 cm (92 x 30 in) Opened Flat	Red/Gray/Black	6.5 kg (14.5 lb)

IMPROVED

Helitack HotSeat™



NFPA 2500
VICTIM EXTRICATION DEVICE

A quick-donning extrication device designed for rapid transport of a patient by helicopter short-haul or hoist.

Features

- Quickly donned in a stable, semi-seated orientation without requiring a harness.
- Interior juvenile restraint system features quick-connect Cobra Buckles for easy closure.
- High-visibility handles aid in positioning and loading.
- Additional handles help the subject maintain upright body position.
- Tagline attachment loops allow controlling and guiding.
- Hoist straps have rigid connection points for optimal handling.
- Safety-Glo accents enhance night visibility.
- Compact design for helicopter storage.
- Includes detachable storage bag that can also store a helmet.
- Hardware proof loaded to 16 kN (3,600 lbs).
- Made of heavy-duty 1,000-denier Cordura® nylon.

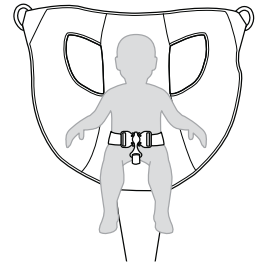
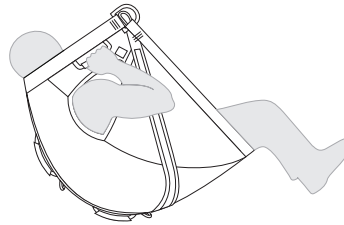

Item #	Dimensions	Color	Load Capacity	Weight
724468	48 x 24 cm (19 x 9.5 in) Packed	Red/Gray/Black	227 kg (500 lb)	2.1 kg (4.7 lb)

Helitack Stork™



This lightweight pediatric rescue carrier can be collapsed for easy stowage on a helicopter.

Helitack Stork Features

- Bottom and sides are lined with 25 mm (1 in) closed-cell foam for structural rigidity and buoyancy.
- Ventilation panels at top can be adjusted for environmental conditions.
- Clear view top panel allows constant visual contact with patient.
- Carrier ends expand to accommodate most pediatric back boards.
- Safety-Glo strips for enhanced visibility.
- Hoist straps feature rigid web handles with steel D-ring attachment points.
- Folds down to 11 x 41. x 79 cm (4.5 x 16 x 31 in).
- Made of heavy-duty 1,000-denier Cordura® nylon and RhinoTek®.



Item #	Dimensions	Color	Load Capacity	Weight
724309	79 x 41 x 30 cm (31 x 16 x 12 in)	Red/Gray/Black	90 kg (200 lb)	3.8 kg (8.4 lb)





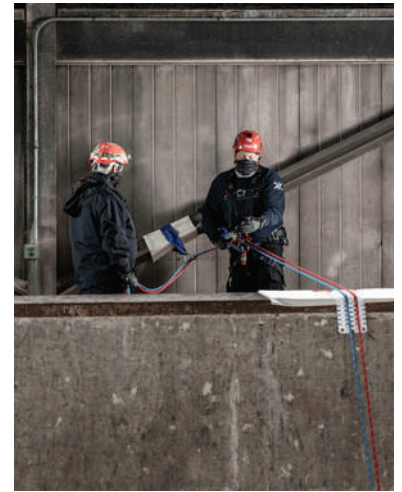

SYSTEMS & KITS

Rigging Kits for team-based operations and Personal Kits for each member of the team



AZTEK ProSeries® System



NFPA 2500
GENERAL USE

In use worldwide, the AZTEK (Arizona Technician's Edge Kit) offers more than 100 rigging solutions in a single bag. An extremely versatile tool, it reflects the philosophy of keeping rigging equipment simple, efficient, non-specialized, light, and compact. Each component has been thoroughly tested and proven to work efficiently as part of this multi-functional system that comes pre-rigged for immediate deployment to the field.

Available Rigging Solutions Include

- Quickly adjust litter attendant position
- High angle litter scoops
- Solo pick-off
- Easily pass knots
- Correct disoriented equipment under load
- Transfer loads
- Establish dynamic fixed brakes
- Pretensioned back-ties
- Redirect anchors
- Establish travel restriction
- Dynamic directionals
- Dynamic lowers
- Hauling systems
- High angle attendant tether
- Load-releasing hitch
- Personal mechanical advantage
- Tensioned guying



AZTEK ProSeries System Comes Assembled and Includes

- AZTEK Omni Pulleys (1 Blue, 1 Orange)
UL Classified to NFPA 2500
- Quick Pin for AZTEK Omni Pulley
- AZTEK ProSeries Cord
Orange, Sewn-Eye Termination
8 mm diameter, 15.2 m (50 ft)
- AZTEK Edge-Pro Tubular Webbing
Blue, 25 mm (1 in) width, 61 cm (24 in)
- ProTech™ Aluminum Auto-Lock Carabiner with Removable Keeper Pin
- AZTEK Bound-Loop Prusik
Orange, 6 mm diameter, 23 cm (9 in)
- AZTEK Bound-Loop Prusik
Blue, 6 mm diameter, 23 cm (9 in)
- AZTEK Bound-Loop Purcell
Blue, 6 mm diameter, 107 cm (42 in)
- Maillon Rapide Quick Link
Oval, 7 mm
- AZTEK ProSeries Pack

Item #	Description	3 Sigma MBS	Weight
500104	AZTEK ProSeries System	36 kN (8,093 lbf)	2 kg (4.3 lb)
300320	Replacement AZTEK Quick-Release Pin (1/4")	N/A	14 g (0.5 oz)

SEE MORE AT CMCPRO.COM

AZTEK Omni Pulleys, Cord, Quick Links, & Prusiks are available for purchase. Visit cmcpro.com to learn more.

AZTEK ProSeries® LT System



NFPA 2500
GENERAL USE

The AZTEK LT (Load Tender) is a compact personal mechanical advantage system with a wide range of applications in rescue and work at height. Designed for quick deployment, the AZTEK LT includes 8.5 m (28 ft) of 8 mm AZTEK ProSeries Cord that can extend the set-of-fours up to 1.8 m (6 ft), providing a 4:1 or 5:1 mechanical advantage. The system comes in an easy-access storage pouch with a quick-connect attachment and web loop. The AZTEK LT also includes two ProTech™ Auto-Lock Carabiners with removable keeper pins for attachment to the swivel ends*.

Available Rigging Solutions Include

- Adjust litter attendant position, low/high
- High-angle attendant tether
- High-angle litter scoops
- Solo pick-off
- Personal mechanical advantage
- Knot passing
- Transfer loads
- Correcting disoriented equipment under load
- Establish dynamic fixed brakes
- Pre-tensioned back-ties
- Redirect anchors
- Load-releasing hitch
- Tensioned guying

AZTEK ProSeries LT System Comes Assembled and Includes

- AZTEK Omni Pulleys (1 Blue, 1 Orange)
UL Classified to NFPA 2500
- Quick Pin for AZTEK Omni Pulley
- AZTEK ProSeries Cord
Orange, Sewn-Eye Termination
8 mm diameter, 8.5 m (28 ft)
- 2 ProTech™ Aluminum Auto-Lock Carabiners with Removable Keeper Pin*
- AZTEK Bound-Loop Prusik
Blue, 6 mm diameter, 23 cm (9 in)
- AZTEK LT / Set of Fours Storage Pouch with Quick Connect Attachment

*The included ProTech™ carabiners must be installed by the user and are UL classified to NFPA Technical Use. When these carabiners are attached, the AZTEK LT only carries an NFPA "T" rating. In order to retain the "G" rating, the user must install "G" rated carabiners.



Item #	Description	3 Sigma MBS	Weight
500106	AZTEK ProSeries LT System	36 kN (8,093 lbf)	1.3 kg (3 lb)



NEW

Harken Wingman™



NFPA 2500
GENERAL USE

The Wingman combines a ratcheting sheave to stop the rope with a composite handle or wing that the operator can open and close under load for a well-modulated ‘fine-tuned’ release. Under a full load, even with the sheaves pulled completely together, the system can be released easily – with full control using one hand on the wing and the other tending the line.

Features

- Internal ratchet and sheaves engineered to maximize rope holding.
- Eccentric progress capture = no prussiks.
- 4:1 or 5:1 mechanical advantage (flip orientation to rig either way).
- Can be released smoothly under full load with one hand.
- High efficiency ball bearing pulleys and audible progress capture.
- Machined aluminum swivel connection points fit multiple connectors.
- Compact, lightweight form factor with 8 inch compressed length.
- 15 m (49 ft) of 8mm low elongation HTP rope allows for 3.7 m (12 ft) system extension.
- Comes in an industrial-grade ballistic nylon carrying bag with locking buckle aluminum.
- System comes ready for use, fully reeved and packed into its storage bag.

Applications

- Personal mechanical advantage
- Solo pick-off
- Knot passing
- Effortless load transfer
- Litter attendant position adjustment
- High-angle attendant tether
- High-angle litter scoops
- Establishing dynamic fixed brakes
- Pre-tensioned back-ties
- Redirect anchors
- Load-releasing hitch
- Tensioned guying
- Correcting equipment orientation under load



Item #	MBS	Weight
720600	45 kN (10,116 lbf)	1.5 kg (3.2 lb)

CSR2 Pulley System™



NFPA 2500
GENERAL USE

This system is an excellent choice for confined space entry or rope access work where a heavy-duty pulley system is desired.

CSR2 Pulley System Features

- Patented locking mechanism is easy to release under load for greater efficiency in confined space rescues.
- Comes with 1.5 m (5 ft) of 4 mm (5/32 in) nylon accessory cord to remotely control the locking mechanism.
- Machined aluminum swivels at both ends of the system eliminate twisting of lines.
- Available with 12.5 mm (1/2 in) or 11 mm (7/16 in) Static-Pro™.
- Pulleys are classified to NFPA and EN standards and machined from solid aircraft-grade aluminum.
- System comes ready for use, fully reeved, and packed into its storage bag.



CSR2 Pulley System with 12.5 mm (1/2 in) Static-Pro.

CSR2 Pulley System Comes Fully Assembled and Includes

- CSR2 Pulley
- CSR2 Double Pulley
- 61 m (200 ft) of 12.5 mm (1/2 in) Static-Pro Red
- **OR** 61 m (200 ft) of 11 mm (7/16 in) Static-Pro Blue
- 2 ProSeries Aluminum Screw-Lock Carabiners
- CMC Rope Bag
- Custom rope lengths available upon request

3 Sigma MBS: 40 kN (8,992 lbf)

Item #	Rope Color	Option	Weight
500102	Red	12.5 mm (1/2 in)	11.3 kg (24.9 lb)
500103	Blue	11 mm (7/16 in)	9.3 kg (20.5 lb)

SEE MORE

CSR2 Pulley

CSR2 Single and Double Pulleys are available separately. **See Page 39.**



CSR2 Pulley System with 11 mm (7/16 in) Static-Pro.



Double CLUTCH™ TTRS Kit







Designed around the CMC CLUTCH™ by Harken™, the Double CLUTCH Twin Tension Rope System (DCTTRS) Kit delivers best practice, twin-tension lowering and hauling for technical operations. The included components allow building mirrored rope systems with 3:1, 5:1, and 9:1 mechanical advantage. The 13 mm (1/2 in) option utilizes rope bags for easy transport of higher volume rope.

Item #	Description
501411	11 mm (7/16 in) option
501413	13 mm (1/2 in) option







Two options available:



11 mm (7/16 in) option









Product	Item #	Qty.
 11 mm (7/16 in) CLUTCH pg. 32	335011	2
 11 mm (7/16 in) CAPTO pg. 30	336011	2
 11 mm (7/16 in) CMC G11, Blue pg. 56	283132-200	1x 200'
 11 mm (7/16 in) CMC G11, Red pg. 56	283133-200	1x 200'
 RigTech Pack, Red pg. 98	441103	1
 RigTech Pack, Blue pg. 98	441102	1

13 mm (1/2 in) option

Product	Item #	Qty.
 13 mm (1/2 in) CLUTCH pg. 32	335013	2
 13 mm (1/2 in) CAPTO pg. 30	336013	2
 12.5 mm (1/2 in) Static-Pro pg. 58	281202	1x 200'
 12.5 mm (1/2 in) Static-Pro pg. 58	281203	1x 200'
 RigTech Pack pg. 98	441103	1
 Rope Bag #2, Red pg. 101	430203	1
 Rope Bag #2, Blue pg. 101	430202	1



Items below are included in both kit options

Product	Item #	Qty.	Product	Item #	Qty.
 Screw-Lock Oval ProSteel Carabiner pg. 45	300093	2	 Anchor Strap Sleeve, Medium pg. 78	294033	2
 Screw-Lock ProSeries Carabiner pg. 42	300221	6	 Ultra Pro 2 Edge Protector pg. 66	294042	2
 1.5" ProSwivel Single Pulley, Stainless Sheave pg. 36	300430	4			
 SQUID Rig Plate pg. 34	300020	1			
 SL FastLink Anchor Strap, Medium pg. 76	201073	2			
 18" Sewn-Loop 8 mm Prusik pg. 61	293083	2			
 Edge Pad, XL pg. 66	294019	2			

PERSONAL KITS



Technical Rope Rescuer Personal Kit

This kit contains the necessary personal equipment for the individual technical rescuer. **See Page 150.**



Rope Rescue Rigging Kit





This Rigging Kit contains the necessary equipment for high or low-angle rope rescue operations. It includes a main and belay line, mechanical advantage, a litter with patient-packaging system, gear for building anchors, AZTEK ProSeries® LT System, and two of the CMC CLUTCH™ by Harken™ for efficient raising and smooth lowering. Innovative features of the CLUTCH make it ideal for technical rescues including the ratcheting rotating sheave, Anti-Panic brake, force limiting protection, and integrated becket.



Item #	Description
501133	11 mm (7/16 in) option
501134	13 mm (1/2 in) option

Two options available:

















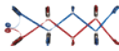







11 mm (7/16 in) option

Product	Item #	Qty.
 11 mm (7/16 in) CLUTCH pg. 32	335011	2
 11 mm (7/16 in) CMC G11, Blue pg. 56	283132-200	1x 200'
 11 mm (7/16 in) CMC G11, Red pg. 56	283133-200	1x 200'

13 mm (1/2 in) option

Product	Item #	Qty.
 13 mm (1/2 in) CLUTCH pg. 32	335013	2
 12.5 mm (1/2 in) Static-Pro, Orange pg. 58	281201	1x 200'
 12.5 mm (1/2 in) Static-Pro, Red pg. 58	281203	1x 200'

Items below are included in both kit options

Product	Item #	Qty.	Product	Item #	Qty.
 Shasta Gear Bag pg. 102	440403	1	 18" Sewn-Loop 8 mm Prusik pg. 61	293083	5
 Truck Cache Case pg. 104	440541	1	 Rope Rescue Technician Manual pg. 5	993221	1
 Litter Pack pg. 107	432401	1	 ProSeries Litter Harness pg. 128	724121	1
 Rope Bag #2, Orange pg. 101	430201	1	 Patient Tie-in System, One-Piece Litter	724151	1
 Rope Bag #2, Red pg. 101	430203	1	 Patient Tie-in System, Pelvic Harness	724153	1
 AZTEK ProSeries LT System pg. 137	500106	1	 Lifesaver Victim Harness pg. 24	202405	1
 Auto-Lock ProTech Carabiner pg. 43	300193	2	 Adjustable Litter Strap pg. 79	201102	4
 Screw-Lock ProSeries Carabiner pg. 42	300221	9	 Stainless Steel Rescue Litter pg. 122	726101	1
 1.5" ProSwivel Single Pulley, Stainless Sheave pg. 36	300430	3	 Anchor Strap Sleeve, Medium pg. 78	294033	2
 1.5" ProSwivel Double Pulley pg. 36	300432	1	 Edge Pad, XL pg. 66	294019	2
 1" Tubular Web, Red pg. 65	200103	2 x 20'	 Ultra Pro 4 Edge Protector pg. 66	294044	1
 1" Tubular Web pg. 65	200107	2 x 12'			
 SL FastLink Anchor Strap, Medium pg. 76	201073	2			
 FastLink Pick-Off Strap pg. 79	201107	1			

PERSONAL KITS



Technical Rope Rescuer Personal Kit

This kit contains the necessary personal equipment for the individual technical rescuer. **See Page 150.**



USAR Task Force Rigging Kit





This Rigging Kit contains the necessary rope rescue equipment for Urban Search and Rescue operations. It includes the primary rope rescue equipment on most FEMA and USAR requirements lists, and serves as an excellent choice for a truck or engine company that responds to over-the-side rescues or needs a vertical lift capability for trench or confined space rescues. The equipment provided allows for a main and belay line, mechanical advantage, litter with patient-packaging system, gear for building anchors, AZTEK ProSeries® LT System, and two of the CMC CLUTCH™

by Harken™ for efficient raising and smooth lowering. Innovative features of the CLUTCH make it ideal for technical rescues including the ratcheting rotating sheave, Anti-Panic brake, force limiting protection, and integrated becket.



Item #	Description
500602	11 mm (7/16 in) option
500603	13 mm (1/2 in) option

Two options available:

















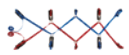







11 mm (7/16 in) option

Product	Item #	Qty.
 11 mm (7/16 in) CLUTCH pg. 32	335011	2
 11 mm (7/16 in) CMC G11, Blue pg. 56	283132-200	1x 200'
 11 mm (7/16 in) CMC G11, Red pg. 56	283133-200	1x 200'

13 mm (1/2 in) option

Product	Item #	Qty.
 13 mm (1/2 in) CLUTCH pg. 32	335013	2
 12.5 mm (1/2 in) Static-Pro, Orange pg. 58	281201	1x 200'
 12.5 mm (1/2 in) Static-Pro, Red pg. 58	281203	1x 200'

Items below are included in both kit options

Product	Item #	Qty.	Product	Item #	Qty.
 Shasta Gear Bag pg. 102	440403	1	 18" Sewn-Loop 8 mm Prusik pg. 61	293083	5
 Truck Cache Case pg. 104	440541	1	 Rope Rescue Technician Manual pg. 5	993221	1
 Litter Pack pg. 107	432401	1	 ProSeries Litter Harness pg. 128	724121	1
 Rope Bag #2, Orange pg. 101	430201	1	 Patient Tie-in System, One-Piece Litter	724151	1
 Rope Bag #2, Red pg. 101	430203	1	 Patient Tie-in System, Pelvic Harness	724153	1
 AZTEK ProSeries LT System pg. 137	500106	1	 Lifesaver Victim Harness pg. 24	202405	1
 Screw-Lock ProSeries Carabiner pg. 42	300221	9	 Adjustable litter Strap pg. 79	201102	4
 1.5" ProSwivel Single Pulley, Stain- less pg. 36	300430	3	 Stainless Steel Rescue Litter pg. 122	726101	1
 1.5" ProSwivel Double Pulley pg. 36	300432	1	 Anchor Strap Sleeve, Medium pg. 78	294033	2
 1" Tubular Web, Blue pg. 65	200102	6 x 15'	 Edge Pad, XL pg. 66	294019	2
 1" Tubular Web, Green pg. 65	200106	6 x 5'	 Ultra Pro 4 Edge Protector pg. 66	294044	1
 1" Tubular Web, Red pg. 65	200103	6 x 20'			
 1" Tubular Web, Yellow pg. 65	200107	6 x 12'			
 SL FastLink Anchor Strap, Medium pg. 76	201073	2			
 FastLink Pick-Off Strap pg. 79	201107	1			

PERSONAL KITS



Technical Rope Rescuer Personal Kit

This kit contains the necessary personal equipment for the individual technical rescuer. **See Page 150.**



Confined Space Rescue Rigging Kit







This Rigging Kit contains the necessary equipment for vertical entry in confined space rescue operations. It includes a primary access line, belay/retrieval system, and patient packaging equipment. The latest products are provided for optimal safety and efficiency including the CMC CSR2 Pulley System™ for 4:1 raising and lowering, the CMC Triskelion™ as artificial high directional, and the CMC CLUTCH™ by Harken™ for smooth rope management. Innovative features of the CLUTCH make it ideal for technical rescues including the ratcheting rotating sheave, Anti-Panic brake, force limiting protection, and integrated becket.





Item #	Description
501302	11 mm (7/16 in) option
501301	13 mm (1/2 in) option

Two options available:













11 mm (7/16 in) option







Product	Item #	Qty.
 11 mm (7/16 in) CLUTCH pg. 32	335011	1
 11 mm (7/16 in) CSR2 Pulley System pg. 139	500103	1
 11 mm (7/16 in) CMC G11, Orange pg. 56	283131-200	1x 200'
 11 mm (7/16 in) CMC G11, Blue pg. 56	283132-200	1x 200'
 11 mm (7/16 in) CMC G11, Red pg. 56	283133-200	1x 200'

13 mm (1/2 in) option

Product	Item #	Qty.
 13 mm (1/2 in) CLUTCH pg. 32	335013	1
 12.5 mm (1/2 in) CSR2 Pulley System pg. 139	500102	1
 12.5 mm (1/2 in) Static-Pro, Orange pg. 58	281201	1x 200'
 12.5 mm (1/2 in) Static-Pro, Blue pg. 58	281202	1x 200'
 12.5 mm (1/2 in) Static-Pro, Yellow pg. 58	281207	1x 200'

Items below are included in both kit options

Product	Item #	Qty.
 Shasta Gear Bag pg. 102	440403	1
 Rope and Equipment Bag pg. 102	431203	1
 Rope Bag #2, Orange pg. 101	430201	1
 Rope Bag #2, Red pg. 101	430203	1
 CMC Triskelion pg. 72	760001	1
 Anchor Plate pg. 51	300610	1
 Screw-Lock ProSeries Carabiner pg. 42	300221	18
 1.5" ProSwivel Single Pulley, Stainless Sheave pg. 36	300430	2
 1" Tubular Web, Red pg. 65	200103	5x 20'
 1" Tubular Web, Yellow pg. 65	200107	4x 12'
 SL FastLink Anchor Strap, Medium pg. 76	201073	1
 18" Sewn-Loop 8 mm Prusik pg. 61	293083	4

Product	Item #	Qty.
 Confined Space Rescue Technician Manual pg. 5	993214	1
 LifeSaver Victim Chest Harness pg. 24	202404	1
 Lifesaver Victim Harness pg. 24	202405	1
 CMC/SKEDCO Drag-N-Lift Harness pg. 130	721805	1
 Edge Pad, XL pg. 66	294019	2
 Anchor Strap Sleeve, Medium pg. 78	294033	1
 Born Entry-Ease pg. 67	735100	1

PERSONAL KITS



Confined Space Entrant Personal Kit

This kit contains the necessary personal gear that a rescuer should have available when making a vertical entry into a confined space **See Page 151.**



Rope Rescue Truck Cache™ Kit



This well-organized kit provides the hardware necessary for setting up a main and belay line. It includes gear for anchors, mechanical advantage, edge protection, and two of the CMC CLUTCH™ by Harken™ for efficient raising and smooth lowering. Innovative features of the CLUTCH make it ideal for technical rescues including the highly efficient ratcheting sheave, Anti-Panic brake, force limiting protection, smooth lowering, and integrated becket.

Item #	Description
501137	11 mm (7/16 in) option
501138	13 mm (1/2 in) option

Two options available:





11 mm (7/16 in) option







Product	Item #	Qty.
 11 mm (7/16 in) CLUTCH pg. 32	335011	2

13 mm (1/2 in) option

Product	Item #	Qty.
 13 mm (1/2 in) CLUTCH pg. 32	335013	2

Items below are included in both kit options



Product	Item #	Qty.
 Truck Cache Case pg. 104	440541	1
 Screw-Lock ProSeries Carabiner pg. 42	300221	5
 1.5" ProSwivel Single Pulley, Stainless Sheave pg. 36	300430	3
 1.5" ProSwivel Double Pulley pg. 36	300432	1

Product	Item #	Qty.
 1" Tubular Web, Red pg. 65	200103	2 x 20'
 SL FastLink Anchor Strap, Medium pg. 76	201073	2
 18" Sewn-Loop 8 mm Prusik pg. 61	293083	2
 Anchor Strap Sleeve, Medium pg. 78	294033	2
 Edge Pad, XL pg. 66	294019	1
 Ultra Pro 4 Edge Protector pg. 66	294044	1

Victim Pick-Off Kit

This kit contains a complete set-up for attaching a stranded subject to a rescuer's system for team-based or rappel-based pick-off. The Pick-Off Strap can be attached to the Lifesaver Victim Harness, and all stored in the bag that comes attached to the harness.

Item # | 500108



Product	Item #	Qty.
 FastLink Pick-Off Strap pg. 79	201107	1
 18" Sewn-Loop 8 mm Prusik pg. 61	293083	2
 Lifesaver Victim Harness pg. 24	202405	1





Litter Harness Kit

This kit includes our Litter Harness in addition to the Patient Tie-In System and Patient Tie-In Pelvic Harness. The AZTEK ProSeries® LT System is included for attaching the litter attendant to the litter harness tender line. Litter sold separately.

Item # | 501106

Product	Item #	Qty.
 Litter Pack pg. 107	432401	1
 AZTEK ProSeries LT System pg. 137	500106	1
 Screw-Lock ProSeries Carabiner pg. 42	300221	4

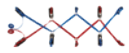

Product	Item #	Qty.
 ProSeries Litter Harness pg. 128	724121	1
 Patient Tie-in System, One-Piece Litter	724151	1
 Patient Tie-in System, Pelvic Harness	724153	1
 Adjustable Litter Strap pg. 79	201102	4













Technical Rope Rescuer Personal Kit



This kit contains the necessary personal equipment that an individual technical rescuer should carry in their pack, including a full-body harness and personal protective equipment (PPE) for the head and hands.

Item # | 501108

Product	Item #	Qty.	Product	Item #	Qty.
 ATOM Rescue Harness, Medium* pg. 14	202124	1	 Kask SuperPlasma HD Helmet pg. 114	346203	1
 Personal Gear Bag pg. 103	441003	1	 Essential Glove, Large* pg. 110	250404	1
 ProPocket pg. 104	434102	1	 Intrinsically Safe EOS II Headlamp pg. 153	130625	1
 Rescue 8, Aluminum pg. 52	300840	1	 18" Sewn-Loop 8 mm Prusik pg. 61	293083	1
 Auto-Lock ProTech Carabiner pg. 43	300193	3	 25" Sewn-Loop 8 mm Prusik pg. 61	293086	1
			 Rope Rescue Technician Field Guide pg. 4	993232	1



*Sizes can be noted at time of purchase



Confined Space Entrant Personal Kit



This kit contains the necessary personal gear that a rescuer should have available when making a vertical entry into a confined space, whether using a retrieval line or being lowered.

Item # | 501203

Product	Item #	Qty.
 <p>ATOM Rescue Harness, Medium* pg. 14</p>	202124	1
 <p>Lassen Duffel pg. 103</p>	440233	1
 <p>Kask SuperPlasma HD Helmet pg. 114</p>	346203	1

Product	Item #	Qty.
 <p>Intrinsically Safe EOS II Headlamp pg. 153</p>	130625	1
 <p>Essential Glove, Large* pg. 110</p>	250404	1
 <p>Confined Space Rescue Technician Field Guide pg. 5</p>	993224	1

*Sizes can be noted at time of purchase













River Rescue Z-Rig



This Rescue Kit includes the water-compatible components necessary for setting up a 3:1 z-rig mechanical advantage system for river rescue incidents. Compact ProTech™ Pulleys minimize bulk and weight, and an included Rappel 8™ allows for controlled lowering.

Item # | 501505

Product	Item #	Qty.	Product	Item #	Qty.
 Rope Bag #2, Yellow pg. 101	430207	1	 Screw-Lock ProTech Carabiner pg. 43	300169	1
 Stuff Bag, Red pg. 106	432303	1	 ProTech Single Pulley pg. 40	300501	3
 Rappel 8, Aluminum pg. 52	300845	1	 11 mm (7/16 in) River Rescue Rope pg. 63	293220	150'
 Anchor Plate pg. 51	300610	1	 Utility Loop pg. 83	201214	1
 Screw-Lock ProSeries Carabiner pg. 43	300161	10	 1" Tubular Web, Yellow pg. 65	200107	2 x 12'
			 18" Sewn-Loop 8 mm Prusik pg. 61	293083	2

SRT Throwline Bag Set



This set features CMC's multi-use SRT Throwline water rescue line, available in several lengths and bag types. The handle makes for easy and accurate throwing and has a quick-release buckle to attach the bag to a boat or PFD. The pack-cloth and mesh bags both have an Ethafoam disk for flotation.

Item #	Line Length	Bag Type	Bag Color	Weight
291100	30 m (100 ft)	Mesh	Yellow	1.7 kg (3.75 lb)
291250	15 m (50 ft)	Pack Cloth	Orange	.9 kg (2 lb)
291275	23 m (75 ft)	Pack Cloth	Orange	1.4 kg (3 lb)



NFPA Throwline Bag Set



This Bag Set combines CMC Rescue NFPA Throwline with an economical pack-cloth bag. The 8 mm diameter line allows for a very compact throw bag.



Color: Orange

Item #	Line Length	Weight
291750	15 m (50 ft)	.5 kg (1.19 lb)
291775	23 m (75 ft)	1.2 kg (2.65 lb)

Redi-Line™ Throwline Bag Set



There should be a throwline in every patrol car, municipal truck, and fire apparatus. This bag set makes preparedness affordable. The pack-cloth bag features a quick-release strap and top handle for easy throwing. An Ethafoam disc provides flotation.

Color: Orange

Item #	Line Length	Weight
291350	15 m (50 ft)	.8 kg (1.81 lb)
291375	23 m (75 ft)	1.2 kg (2.65 lb)

EZ-Stuff™ Throwline Bag Set

With a flat bottom and unique side-grommet, the EZ-Stuff Throwline Bag Set stands up and stays open while rope is fed into it.



Features

- Includes 15 m (50 ft) of high-performance NFPA Throwline.
- Short, stocky design allows more room for a hand when feeding rope.
- Quick-release top handle makes throwing the bag more accurate and allows it to clip to a PFD or belt.
- Safety-Glo stripe enhances visibility in low-light conditions.
- Flotation is built directly into the bag.

Item #	Line Length	Weight
291550	15 m (50 ft)	.6 kg (1.25 lb)



ResQmax™ Swiftwater Rescue Kit

The Sling Projectile inflates on contact with the water to become a flotation collar or easy-to-hold floating ring for the subject. The 91 m (300 ft) 8 mm Polyspectra line floats and has a tensile strength of 9.8 kN (2,200 lbf). The average launch distance with the sling projectile is 61 m (200 ft).



ResQmax Swiftwater Rescue Kit Includes

- ResQmax Launcher with Folding Stock
- Streamline Sling Projectile with two spare molded sling burst capsules
- 91 m (300 ft) x 8 mm Polyspectra Line with large line container (9.8 kN/2,200 lbf test)
- Corrosion Block Lubricant/Rust Inhibitor
- Streamline Filler Hose Assembly
- Cordura® Nylon Carry Bag, Red/Black
- Streamline Nozzle Protectors (Pack of 5)
- CO2 Capsules and H2O Soluble Bobbins (Pack of 5)
- Spares kit
- Operations Manual

Item #	Line Length	Line Diameter	Color	Weight
564020	91 m (300 ft)	8 mm (5/16 in)	Red/Black	10.8 kg (23.8 lb)

ResQmax™ Line Deployment Kit



This kit contains everything needed to launch a 3 mm messenger line up to 107 m (350 ft). The 152 m (500 ft) Dacron® line has a tensile strength of 2.2 kN (500 lbf). Once the messenger line is across, it can be used to pull across a rescue rope.



ResQmax Line Deployment Kit Includes

- ResQmax Launcher with Folding Stock
- Streamline Line Projectile with two spare molded projectile protectors
- 152 m (500 ft) Dacron® messenger line (2.2 kN / 500 lbf test) with compact line container
- Spares kit
- Corrosion Block Lubricant/Rust Inhibitor, 113 g (4 oz)
- Streamline Filler Hose Assembly
- Cordura® Nylon Carry Bag, Red/Black
- Streamline Nozzle Protectors, (Pack of 5)
- Operations Manual
- Training CD

Item #	Line Length	Line Diameter	Color	Weight
564000	152 m (500 ft)	3 mm (1/8 in)	Red/Black	7.9 kg (17.5 lb)

ResQmax Distance Chart

Performance figures shown below represent conservative values achievable by someone who has received basic training in the use of the equipment.

Line Type	Horizontal w/ Line Projectile	Horizontal w/ Sling Projectile	Vertical w/ Grappling Hook
7 mm Black – Nylon/Spectra Braid	50 m (165 ft)	50 m (165 ft)	24 m (80 ft)
5.5 mm Black – Nylon/Spectra Braid	85 m (280 ft)	70 m (230 ft)	33 m (110 ft)
3 mm White – Dacron® Polyspectra Braid	122 m (400 ft)	91 m (300 ft)	Not Applicable
8 mm Yellow w/ Red Tracer – Polyspectra Water Rescue	76 m (250 ft)	61 m (200 ft)	Not Applicable

ResQmax™ Complete Kit



The ResQmax Complete Kit provides versatility by including a Line Projectile for delivering a messenger line and a Sling Projectile for deploying an inflatable sling. Each line has its own compact container, ready for instant deployment. The kit comes packed in a rugged Pelican Case with molded liner.



ResQmax Complete Kit Includes:

- ResQmax Launcher with Folding Stock
- Streamline Line Projectile with two spare molded projectile protectors
- Streamline Sling Projectile with two spare molded sling burst capsules
- 152 m (500 ft) Dacron® messenger line with compact line container (2.2 kN/500 lbf) test
- 84 m (275 ft) Polyspectra Water Rescue Line with compact line container
- CO2 capsules and water soluble bobbins, (Pack of 5) (Not Shown)
- Spares Kit (Not Shown)
- 113 g (.25 lb) Streamline Filler Hose Assembly
- Pelican Case with molded insert liner
- Streamline Nozzle Protectors, (Pack of 5)
- Operations Manual
- Training CD

Item #	Line Length	Line Diameter	Weight
564060	152 m (500 ft) Messenger	3 mm (.125 in) Messenger	25.8 kg (56.9 lb)
	84 m (275 ft) Water Rescue	8 mm (.31 in) Water Rescue	

ResQmax™ Optional Equipment



The molded interior of the ResQmax Complete Kit Pelican Case can hold one additional projectile of any type, one filler hose assembly adapter, a ResQmax Tool Kit and up to 3 additional Pack-of-5 consumables.



Item #	Description	Weight
563000	Streamline Line Projectile	1 kg (2.2 lb)
563050	Streamline Training Projectile, Red Cover	850 g (1.9 lb)
567120	CO2 Capsules and Water Soluble Bobbins (Pack of 5)	NA

ResQmax™ Grappling Hook



A fixed grappling hook with three non-barbed tines. Made from titanium for high strength and low weight.



Item #	Weight
567010	907 g (2 lb)

Contact CMC Customer Support for the full line of ResQmax Products at info@cmcpro.com





QUICK REFERENCE

EDUCATION	1	HARDWARE	29	CMC Lifeline™	59
Rope Rescue Technician I/II	2	CAPTO™	30	Teufelberger KM III	60
Rope Rescue Technician III	2	CAPTO™ Soft Shackle	30	Prusik & Load Release Hitch Cord	61
Confined Space Rescue Technician	2	CMC CLUTCH™ by Harken™	32	Sewn-Loop Prusiks	61
Trench Rescue Technician	3	SQUID™ Rig Plate	34	AZ Bound-Loop Prusiks	61
Structural Collapse Shoring	3	MPD™ (Multi-Purpose Device)	35	NFPA Throwline	62
REMS/Remote Rescue Workshop	3	ProSwivel™ Pulley	36	SRT Throwline	62
Arizona Vortex Workshop	3	ProSwivel™ SwivaBiner	38	Redi-Line™ Throwline	62
Vertical Skills Class	3	CSR2 Pulley	39	River Rescue Rope	63
Rope Rescue Technician Manual	4	Kootenay Ultra Pulley	39	Escape Line	63
Rope Rescue Technician Field Guide	4	Rescue Pulley	40	ProSeries® Escape Line	63
Trench Rescue Technician Manual	5	ProTech™ Pulley	40	Reflective RIT Line	64
Confined Space Rescue Technician Manual	5	Enforcer Load Cell Kit	41	Ladder Line	64
Confined Space Rescue Technician Field Guide	5	Swivels	41	Halyard Clamp	64
		ProSeries® Aluminum Key-Lock Carabiner	42	Tubular Web	65
HARNESSES & BELTS	11	ProTech™ Aluminum Key-Lock Carabiner	43	Flat Web	65
ATOM™ Rescue Harness	14	Aluminum Oval Carabiner	43	Fire Escape Web	65
ATOM™ Access Harness	15	Stainless Steel Carabiner	44	Ultra-Pro™ Edge Protectors	66
ATOM™ Global Harness	16	DMM Vault Lock Tool Carrier	44	Edge Pad	66
ATOM™ Global Quick Harness	16	ProSteel™ Carabiner	45	Edge Guard	67
ATOM™ Chest Ascender Kits	17	DNA Carabiners	45	Born Entry-Ease	67
SkySaddle™	17	CMC Ascender	46		
ATOM™ Sit Harness	18	Harken Ninja™ Foot Ascender	46	ANCHORS & STRAPS	69
ATOM™ Chest Harness	18	Climbing Technology Quick Up Ascender	47	Arizona Vortex Kit	70
Ranger Harness™	19	Climbing Technology Quick Roll Ascender	47	CMC Triskelion™	72
Ranger Quick Harness™	19	Harken Ninja™ MultiAscend	48	Harken LokHead Winch Kit	74
Ranger Chest Harness™	19	Climbing Technology Chest Ascender HC	49	Harken Traction Winch 500	75
Outback™ Convertible Harness	20	Kong Futura Body	49	Sked-EVAC Industrial Tripod	75
Confined Space Harness™	22	Kong Backup & Magnet	50	SL Anchor Straps	76
Helitack Harness™	22	Anchor Plate	51	Anchor Straps	77
Tactical Rappel Harness™	23	Micro-Anchor Plate	51	Anchor Strap Sleeve	78
Pronto Evac™ Harness	23	Spreader Bar	51	Load Release Strap	78
Utility Harness	23	Rescue 8™	52	FastLink™ Pick-Off Strap	79
Lifesaver Victim Harness™	24	Rappel 8™	52	Pick-Off Strap	79
Lifesaver Victim Chest Harness™	24	Survivor 8™	52	Adjustable Litter Strap	79
Uniform Rappel Belt™	25	Maillon Rapide Quick Links	53	Texora™ Slings	80
Trench Work-Rescue Belt™	25	Kong Trapezium Quick Link	53	CMC Lanyards	81
Cobra-D Uniform Rappel Belt™	25	Aluminum O-Ring	53	BOOST™ Foot Loop	82
Ladder Belt	26	Steel O-Ring	53	Adjustable Foot Loop	83
K9 ProSeries® Rappel Harness	26			Utility Loops	83
Dualcom™ Radio Harness	27	ROPE & WEB	55	8 Link	83
ProSeries® Radio Harness	27	CMC G11™	56	Multi-Loop Strap	83
Radio Holster	27	Static-Pro™	58	Derby Helo Strap™	84



Water Rescue Tether	84	Kask Zenith X2 Helmet	115	Helitack AirBag™	132
Tactical Tether	84	Kask Helmet Decal Set	115	Helitack HotSeat™	133
Azzard Tower Climbing Connector	85	Sunbrero™	116	Helitack Stork™	133
Y-Shok Lanyard™	85	CMC Pro Team Tee	116		
Bypass Lanyard	85	CMC Stainless Steel Cup	117		
		CMC Patch	117		
FIRE ESCAPE	87	CMC Pro Team Insulated Bottle	117	SYSTEMS & KITS	135
LEVR™ Escape System	88	CMC Insulated Camper Mug	117	AZTEK ProSeries® System	136
LEVR™ BT Escape System	90	CMC Sticker	117	AZTEK ProSeries® LT System	137
Flash Escape™ Anchor	92	CMC Trucker Hat	118	Harken Wingman™	138
Fulcrum Escape™ Belt	93	CMC Doo-Rag	118	CSR2 Pulley System™	139
RIT Kit	93	CMC Pro Team Hat	118	Double CLUTCH™ TTRS Kit	140
Survivor™ 8 Escape System	93	CMC Buff	118	Rope Rescue Rigging Kit	142
		78 Pack™	119	USAR Task Force Rigging Kit	144
BAGS & PACKS	95	Mountain Heritage Hat	119	Confined Space Rescue Rigging Kit	146
Lotus Tech Pack™	96	Mountain Mug	119	Rope Rescue Truck Cache™ Kit	148
RigTech Pack™	98			Victim Pick-Off Kit	149
Whitney 2.0™	99	PATIENT CARE & TRANSPORT	121	Litter Harness Kit	149
Palisade 2.0™	100	Stainless Steel Rescue Litter	122	Technical Rope Rescuer Personal Kit	150
Rope Bags	101	Stainless Steel Split-Apart Rescue Litter	122	Confined Space Entrant Personal Kit	151
Rope & Equipment Bags™	102	Titanium Rescue Litter	123	River Rescue Z-Rig	152
Shasta Gear Bag™	102	Titanium Split-Apart Rescue Litter	123	SRT Throwline Bag Set	152
Lassen Duffel Bag™	103	Disaster Response Litter	124	NFPA Throwline Bag Set	153
Personal Gear Bag	103	Traverse Advantage Plastic Litter	124	EZ-Stuff™ Throwline Bag Set	153
Truck Cache™	104	Traverse Mule II Litter Wheel	125	Redi-Line™ Throwline Bag Set	153
Pro Pocket™	104	Vertical-Lift Litter Harness	125	ResQmax™ Swiftwater Rescue Kit	154
Equipment Storage Bag	104	Litter Shield	126	ResQmax™ Line Deployment Kit	154
AZTEK ProSeries® Pack	105	Litter Shield Plus	126	ResQmax™ Complete Kit	155
Set of Fours Pouch	105	Patient Tie-In System	127	ResQmax™ Optional Equipment	155
Outback™ Pouch	105	Skedco Oregon Spine Splint II	127	ResQmax™ Grappling Hook	155
Stuff Bags	106	ProSeries® Litter Harness	128		
Throwline Bags (Bag Only)	106	Rescue Litter Harness	128		
Water Rescue Gear Bag	106	Low-Angle Litter Harness	128		
Litter Pack	107	HMH Sked® Stretcher	129		
SCBA Mask Protector	107	Litter Flotation Collar	129		
Tactical Leg Bag	107	Litter Cover	129		
PERSONAL GEAR	109	Sked® Stretcher Flotation System	129		
Essential Glove	110	CMC/Skedco® Drag-N-Lift Harness™	130		
Rappel Glove	112	Half-Sked® Patient Drag	130		
Princeton Tec® Eos II Intrinsically Safe Headlamp	113	Sked® Basic Rescue System	131		
Princeton Tec® Apex Headlamp	113	Sked® Basic Rescue System with Cobra™ Buckles	131		
Kask Superplasma HD Helmet	114	Sked-Evac Cobra™ Buckle Conversion Kit	131		



PRODUCT INDEX

A

Accessory Cord 61
 Air Operations Gear 22, 132, 133
 Anchor Plates 34, 51
 Anchor Straps 76, 77, 78, 79
 Apparel/Insignia 116, 117, 118, 119
 Arizona Vortex 70, 71

Ascenders 46

Chest Ascender 48, 49
 Foot Ascender 46
 Handled Ascender 47

ATOM Chest Ascender Kit 17

ATOM Harnesses 12, 13, 14, 15, 16, 18

AZTEK ProSeries System 136

B

Backup Device 50

Bags

Rope Bag 101
 Rope & Equipment Bags 102
 Stuff Bags 106

Belts 25

Escape Belt 93
 Ladder Belt 26

Books 4, 5

Buff 118

C

Caps 118, 119

CAPTO 30, 31

Carabiners

Aluminum 42, 43
 DNA 45
 Steel 44, 45

Classes 2, 3

CLUTCH 32, 33

Con-Space Kits 138

D

Descenders 32, 35, 52

Dog Harness 26

E

Edge Protectors 66, 67, 78

Enforcer Load Cell 41

Escape Belts 25, 26

Escape Line 63

Escape System 88, 90, 93

F

Field Guides 4, 5

Figure 8 Descender 52

Flash Escape Anchor 88, 90, 92

Foot Loop 82, 83

G

G11 Lifeline 56-57

Gloves 110, 112

H

Halyard Clamp 64

Harnesses

Accessory 17, 44
 ATOM Harness Series 12, 13, 14, 15, 16, 18
 Class II Harnesses 18, 19, 20, 23
 Class III Harnesses 12, 13, 14, 15, 16, 20, 22
 K9 26
 Life Safety Harness 24
 Outback Convertible Harness 20
 Radio Harnesses 27

Hat 118, 119

Headlamps 113

Derby Helo Strap 84

Helitack AirBag 132

Helitack HotSeat 133

Helitack Stork 133

Helmets 114, 115

Holster, Radio 27

L

Ladder Line 64

Lanyards 81, 85

LEVR Escape System 89, 90

Life Safety Rope 59

Lights 113

Line Thrower 153, 154



Litters 122, 123, 124
 Cover 129
 Harnesses 125, 128
 Pack 107
 Shield 126
 Wheel 125

Load Release Strap 78

M

Manuals 4, 5
 MPD 35

Multi-Loop Strap 83

O

Oregon Spine Splint II 127

O-Ring 53

Outback Convertible Harness 20

P

Patient Tie-In 127

Personal Escape 88, 90, 92, 93

Pick-Off Strap 79

ProSwivel™ Pulley 36

ProSwivel™ SwivaBiner 38

Prusik Cord / Prusiks 61

Pulleys 39, 40

CSR 39

Q

Quick Links 53

R

Radio Harness 27

Rescue Harnesses 18, 19, 22, 23, 24, 25, 26

ResQmax 154, 155

Rig Plate 34, 51

Rope Bag 101

Rope Protection 66, 67

Rope / Web

Escape Line 63

Flat Web 65

G11 56

Kernmantle Ropes 58, 59, 60

Ladder Line 64

Lifeline 59

Prusik Cord 61

Sewn-Loop Prusiks 61

Throwline 62

Tubular Web 65

S

Screw Links 53

Slings 80

Spreader Bar 51

SQUID 34

Straps

Anchor Strap 76

Derby Helo Strap 84

Litter Strap 79

Pick-Off Strap 79

Strap Sleeve 78

Stretchers 122, 123, 124, 127, 129, 130, 131

Cover 129

Harnesses 125, 128

Shield 126

Wheel 125

Swivels 41

Systems 136, 137, 138, 139

T

Tactical Gear 84, 107

Tether 84

Throwline Bag Sets 152, 153

Training 2, 6

Trapezium Quick-Link 53

Tripods 75

Arizona Vortex 71

Triskelion 72, 73

Triskelion 72, 73

T-Shirt 116

V

Victim Chest Harness 24

Victim Harness 24

W

Webbing 65

Winches 74, 75

ORDERING INFORMATION

Ordering Terms + Conditions: By placing an order the customer acknowledges agreement to the terms and conditions stated below and acknowledges having read and understood the important warnings below. The customer further agrees that the laws of the State of California shall apply to the purchase or any dispute arising therefrom.

Prices: All prices are FOB Goleta, California USA and are subject to change without notice.

Specifications: Specifications in the catalog are based on each manufacturer's representations. CMC Rescue, Inc. is not responsible for their accuracy or completeness. All specifications are subject to change without notice.

Payment: Payments shall be in the legal tender of the United States. Shipments may be held for checks to clear. All fees incurred in collecting a past due account are the responsibility of the purchaser. A service fee will be charged for any check returned by the bank.

Shipping: Delivery to the carrier constitutes delivery to the customer. Visible damage should be reported to the carrier when the package is received. Notify CMC of any problems immediately. Claims reported more than 15 days after receipt may be denied.

Return Policy: Contact CMC for a Return Merchandise Authorization (RMA) number before returning any merchandise for any reason. CMC is not responsible for merchandise returned without an RMA number. Returned merchandise will be inspected and may be subject to a restocking fee. Absolutely no returns on rope, web or web products, unless the item was received in a damaged condition and an RMA number requested within five days of receipt of shipment. On all other returns, an RMA must be requested within 15 days of invoice date.

Adult Signature Required on Deliveries: For liability reasons, CMC can only accept orders from adults.

CMC LIMITED WARRANTY

CMC warrants to the original purchaser that CMC manufactured products will be free from defects in materials and workmanship. Visit cmcpro.com for warranty details.

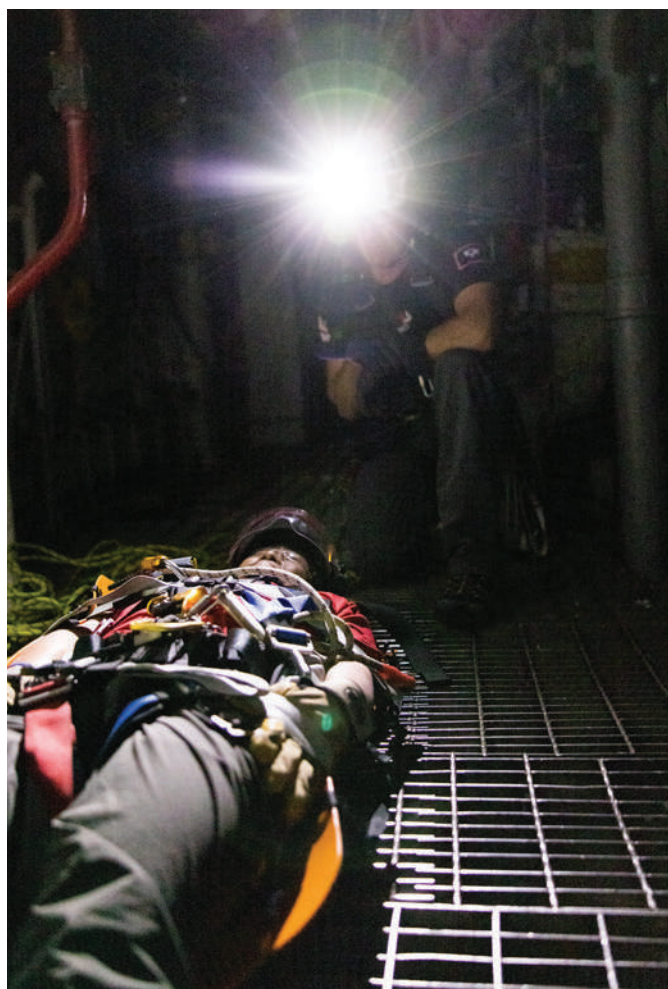

CMC CUSTOMER SUPPORT

Monday–Friday, 7am–5pm Pacific Standard Time (PST)

US

Phone: 805-562-9120

Fax: 805-562-9870

Global

Phone: 800-235-5741

Fax: 800-235-8951

E-mail:

info@cmcpro.com

Website:

cmcpro.com

Mailing address:

6740 Cortona Drive Goleta, California 93117 USA

PHOTO CREDIT

Page 121:

Photo by Tom Nickel of 2022 CMC GRIMP North America Team, Namur Fire Fighters rom Namur, Belgium.

Page 135:

Photo by Ryan Flanagan featuring Cassy Aguirre and Aspen Wilks from Women in Rescue



IMPORTANT WARNINGS

Many of the activities for which CMC products are used pose a very substantial risk of serious injury or death. Be certain you carefully review all of the following information. Products manufactured and sold by CMC Rescue, Inc. are intended for use by professionals trained and experienced in the use, inspection and maintenance of these products. All individuals using CMC products must have this same professional level of skill. Technical rescue, rappelling, climbing and the training involved are very hazardous activities. Each situation has its own unique conditions and must be evaluated by those present. Effective risk management comes from experience, proper training and good personal judgment.

Limits of Liability CMC is not liable for any damages arising from abuse or improper use of the equipment, failure to follow adequate safety precautions or breach of the duty of either the purchaser or user. Adequate training and judgment are needed to reduce the risks inherent in the use of this equipment. Since these risks are out of the control of CMC, the liability shifts to the user and purchaser.

Duty of Purchaser and User It is the responsibility of the purchaser and the user of products manufactured and sold by CMC to:

Read the product instructions and labels and follow them. If you do not have a copy of the instructions, request a copy from CMC, 6740 Cortona Drive, Goleta, CA 93117.

Inspect the product immediately after purchase and before and after each use. Read the note on inspection below.

Receive training in the proper use of the equipment and in the appropriate techniques. Proper training includes safety procedures, limitations of the equipment, inspection of equipment and risk management. If you are not competent in the use of the product, do not use it. See the note on training below.

Determine if the product is suitable for its intended use and that it meets all applicable standards and regulations. The manufacturer can provide assistance but cannot be expected to be knowledgeable of all worldwide standards and regulations.

Use good judgment and do not exceed the limitations of the user's skill or of the equipment.

Use adequate safety precautions, including belays and backup systems. Practice risk management at all times.

Do not alter the product in any way. Repairs must be done only according to the manufacturer's instructions or returned to the manufacturer for repair. Alterations will void warranty.

If the purchaser is not the user of the product, the purchaser must provide each user with a copy of this notice and the product instructions. If additional copies of this notice or the product instructions are needed, they can be obtained from CMC.

Inspection: Each department involved in rescue operations is expected to have a policy for inspecting life-safety equipment. Inspection should be no less than after each use, and inspections must be done by personnel that meet the department's training standard for inspecting life-safety equipment. Inspection dates should be recorded on a tag attached to the equipment or in the equipment log. Each user should be trained in equipment inspection and should do a cursory inspection before each use.

Training: It is the responsibility of the purchaser to ensure that the user is adequately and competently trained in the use of the product. Training is available from several sources, including the CMC School (see page cmcpro.com/school for more information). The publications section of this catalog also includes a variety of reference guides to assist in the selection and use of the products.



© 2024 CMC Rescue, Inc.

All rights reserved CMC and X are registered marks of CMC Rescue Inc.





6740 Cortona Drive
Goleta, California 93117 USA

CATALOG 131



99131D



FSC

www.fsc.org

MIX
Paper from
responsible sources
FSC® C023

PRINTED IN THE USA